



RING DINING TABLE

TECHNISCHES BLATT
SCHEMA TECNICA
DATA SHEET
FICHE TECHNIQUE

RING DINING TABLE

DESIGN GEBRÜDER THONET VIENNA GmbH (GTV), 2015



Tisch mit Gestell aus Buchenbu-gholz und Tischplatte aus furnierter Buche.

Tavolo con struttura in faggio curvato e piano impiallacciato in faggio.

Table with bent beech-wood frame and beech-wood veneer top.

Table avec structure en hêtre cintré et plateau en hêtre plaqué.





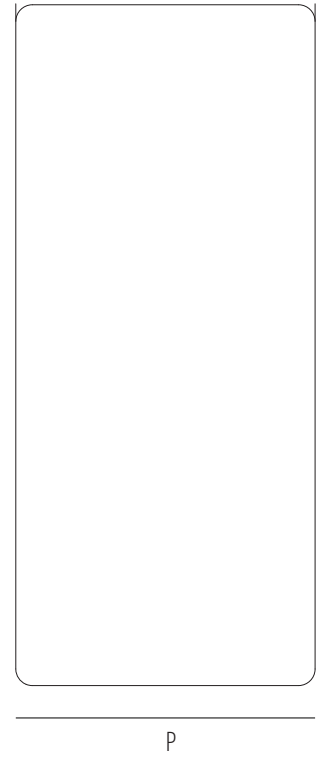
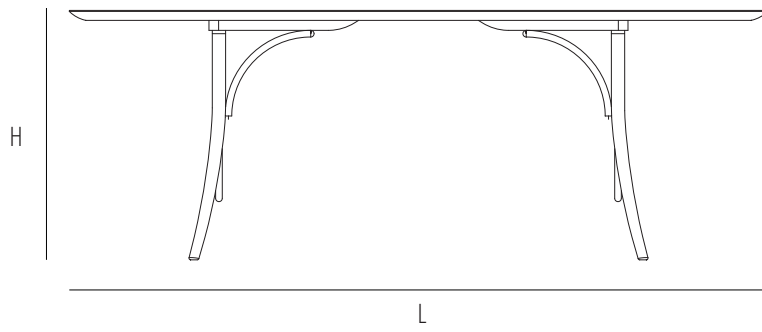

TVRINDLGN

Dimensions mm.
height 750 | width 2100 | depth 900

	mm	inch
H	750	29,5
L	2100	82,6
P	900	35,4
Hs		
Hb		

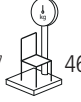
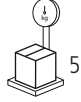

 1
  max 1
  Legs 0,39
  Top 0,17
  46
  52

Legs		Top	
mm - inch	h	mm - inch	h
h	960 - 37,7	h	960 - 37,7
l	750 - 29,5	l	2120 - 83,4
p	540 - 21,2	p	80 - 3,1

Verfuegbare Ausfuehrungen
Finiture disponibili
Available finishes
Finitions disponibles

WOOD

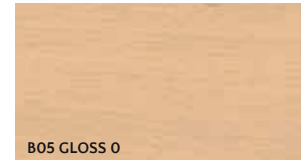
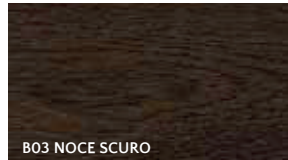

CLASSIC

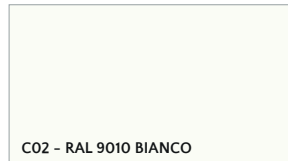
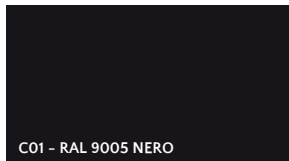

CONTEMPORARY

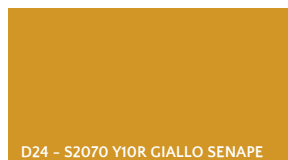
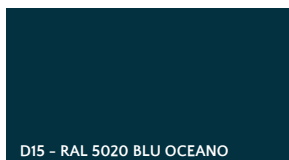
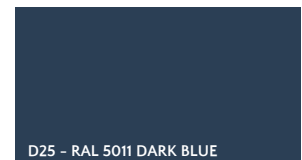
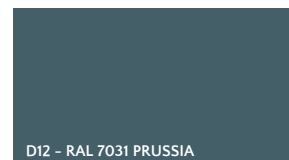
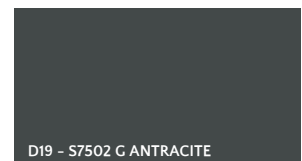
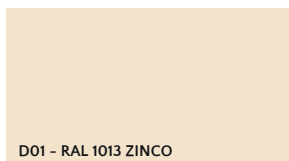

Gebrüder Thonet Vienna GmbH
Prinz Eugen Straße 42
1040 Wien (AT)

www.gebruederthonetvienna.com

Offices of the trademarks' licensee
Production Furniture International S.p.A.
Via Foggia, 23/H
10152 Torino (TO) Italy

Phone: 0039 011 0133330 - info@gebruederthonetvienna.com