



N.811 BARSTOOL
& COUNTER

TECHNISCHES BLATT
SCHEMA TECNICA
DATA SHEET
FICHE TECHNIQUE

N.811 BARSTOOL & COUNTER

DESIGN JOSEF HOFFMANN, 1930



Barhocker und Counter aus Buchenbugholz. Erhältlich in 3 Versionen: Sitz und Rückenlehne aus Wiener Geflecht, gepolsterter Sitz und Rückenlehne aus Wiener Geflecht, gepolsterte Sitz und Rückenlehne.

Sgabello da bar e counter in faggio curvato. Disponibili in 3 versioni: seduta e schienale in paglia di Vienna, seduta imbottita e schienale in paglia di Vienna, seduta e schienale imbottiti.

Bent beech-wood barstool and counter stool. Available in 3 versions: woven cane seat and backrest, upholstered seat and woven cane backrest, upholstered seat and backrest.

Tabouret bar et counter en hêtre cintré. Disponibles en 3 versions: assise et dossier en paille de Vienne, assise rembourrée et dossier en paille de Vienne, assise et dossier rembourrés.

Taburete de bar de haya curvada y mostrador. Disponible en 3 versiones: asiento y respaldo de paja de Viena, asiento tapizado y respaldo de paja de Viena, tapizados paja de Viena, asiento y respaldo tapizados.



SA0811PGL

Dimensions mm.
height 1085 | width 410 | depth 500



SA0811TES

Dimensions mm.
height 1085 | width 410 | depth 500



SA0811TE2

Dimensions mm.
height 1085 | width 410 | depth 500



SM0811PGL

Dimensions mm.
height 1010 | width 410 | depth 500



SM0811TES

Dimensions mm.
height 1010 | width 410 | depth 500



SM0811TE2

Dimensions mm.
height 1010 | width 410 | depth 500

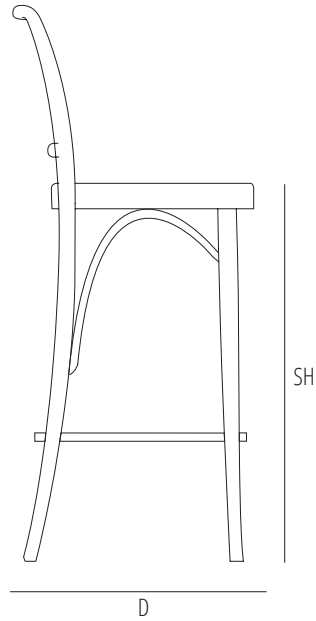
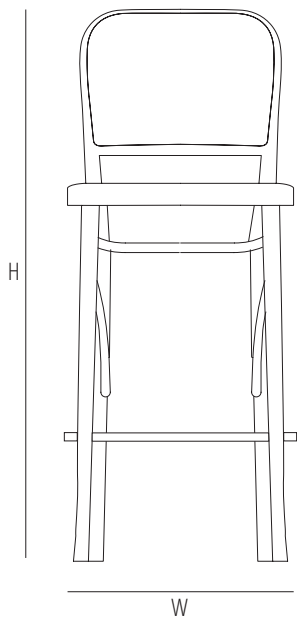

	H	W	D	SH	AH
mm	1085	410	500	750	
inch	42,7	16,1	19,6	29,5	

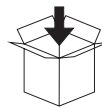
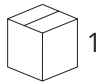

max. 1

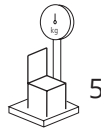
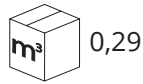

5

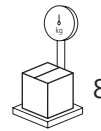

8

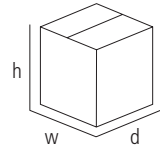

mm - inch
h 1200 - 47,2
w 450 - 17,7
d 550 - 21,6

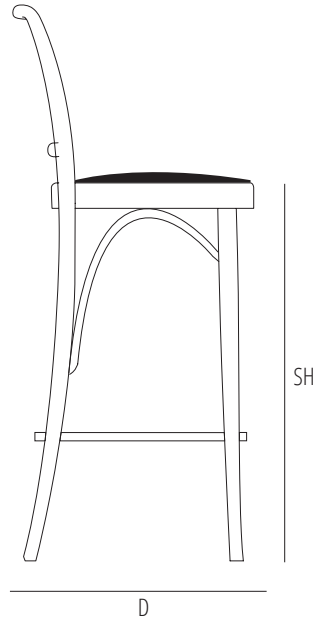
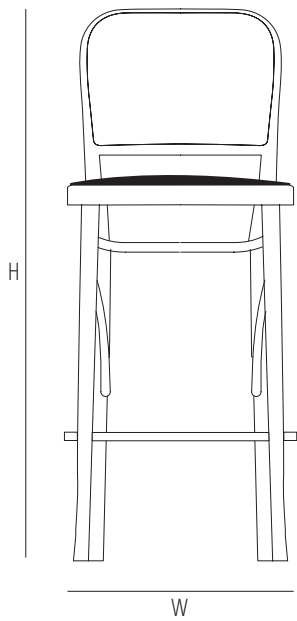

	H	W	D	SH	AH
mm	1085	410	500	750	
inch	42,7	16,1	19,6	29,5	

1 Pz/Pc: 50 cm. Linear x 140 cm h/width

2 Pz/Pc: 50 cm. Linear x 140 cm h/width

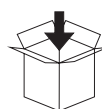
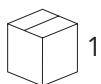

max. 1

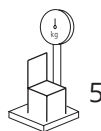
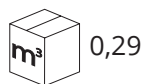

5

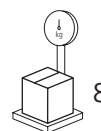

8

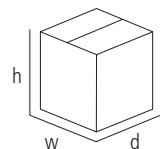

mm - inch
h 1200 - 47,2
w 450 - 17,7
d 550 - 21,6

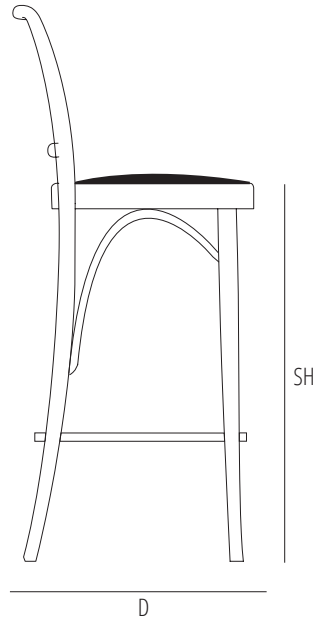
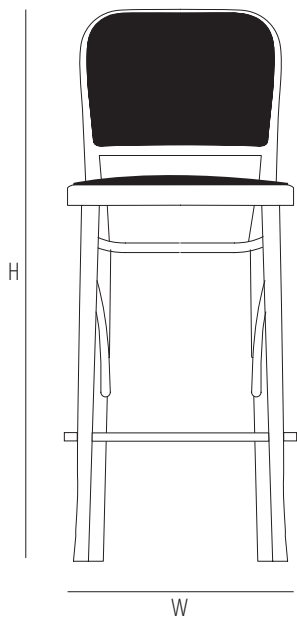

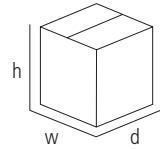
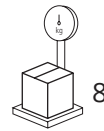
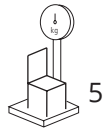
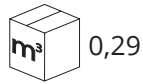
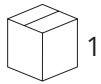

	H	W	D	SH	AH	
mm	1085	410	500	750		1 Pz/Pc: 50 cm. Linear x 140 cm h/width
inch	42,7	16,1	19,6	29,5		2 Pz/Pc: 100 cm. Linear x 140 cm h/width

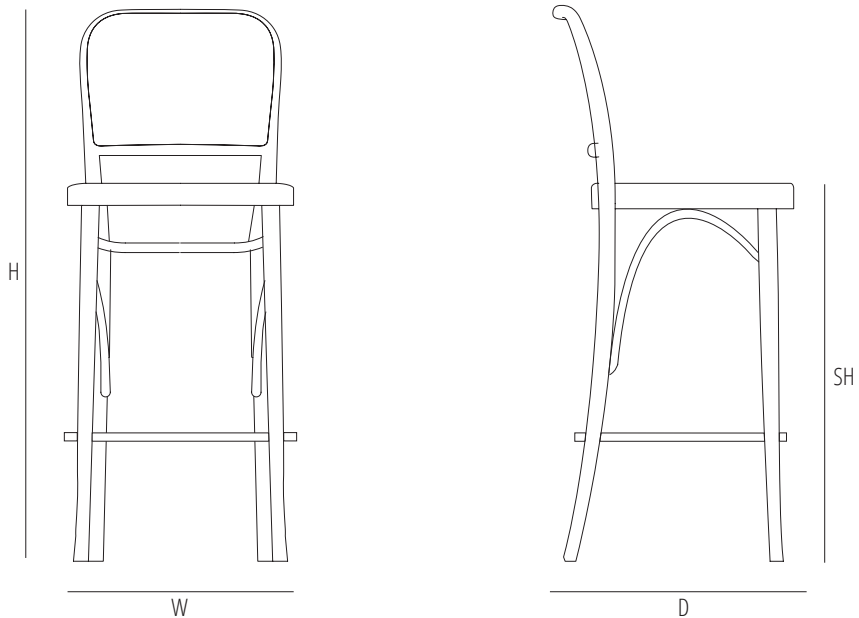

mm - inch
 h 1200 - 47,2
 w 450 - 17,7
 d 550 - 21,6



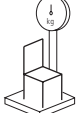
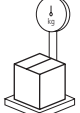
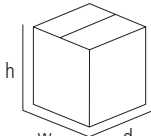

	H	W	D	SH	AH
mm	1010	410	500	650	
inch	39,7	16,1	19,6	25,5	

 1
  max. 1
  0,29
  5
  8
 

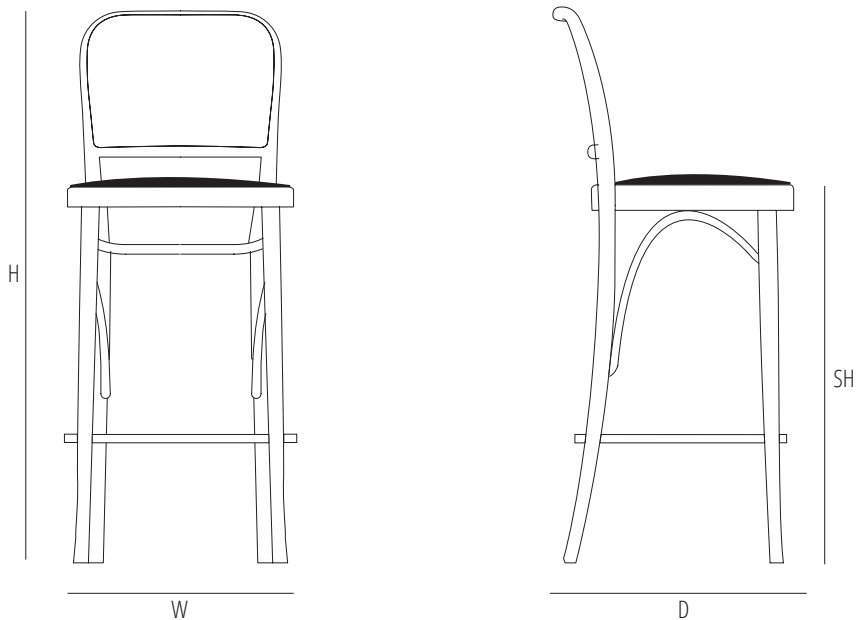
mm - inch
 h 1200 - 47,2
 w 450 - 17,7
 d 550 - 21,6

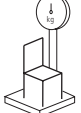
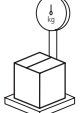
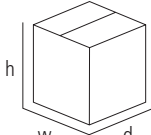

	H	W	D	SH	AH
mm	1010	410	500	650	1 Pz/Pc: 50 cm. Linear x 140 cm h/width
inch	39,7	16,1	19,6	25,5	2 Pz/Pc: 50 cm. Linear x 140 cm h/width

 1
  max. 1
  0,29
  5
  8
 

mm - inch
 h 1200 - 47,2
 w 450 - 17,7
 d 550 - 21,6

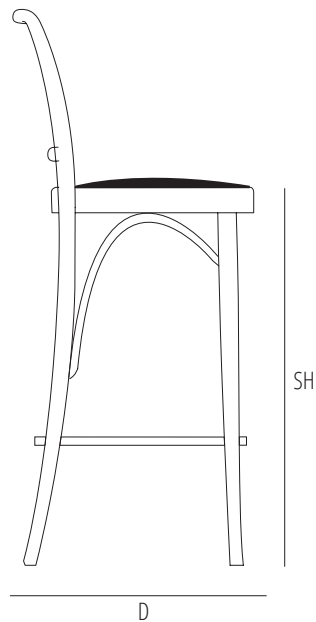
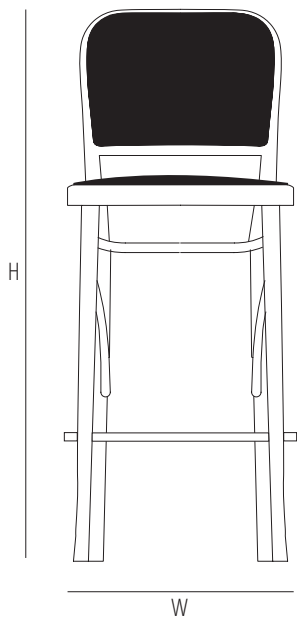

	H	W	D	SH	AH	
mm	1010	410	500	650		1 Pz/Pc: 50 cm. Linear x 140 cm h/width
inch	39,7	16,1	19,6	25,5		2 Pz/Pc: 100 cm. Linear x 140 cm h/width

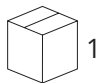

1



max. 1



0,29

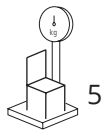

5

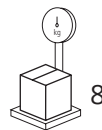

8

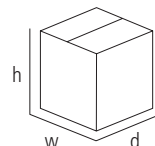

mm - inch
 h 1200 - 47,2
 w 450 - 17,7
 d 550 - 21,6

Verfuegbare Ausfuehrungen
Finiture disponibili
Available finishes
Finitions disponibles

SOLID WOOD / ESSENZE NATURALI



B01 BEECH
B01 FAGGIO

STAINS / TINTI



B03 DARK WALNUT
B03 NOCE SCURO



B04 WENGE
B04 WENGE



B08 BEECH-WOOD STAINED IN NOCE CANALETTO
B08 FAGGIO TINTO NOCE CANALETTO

CLASSIC LACQUER / LACCATO CLASSICO

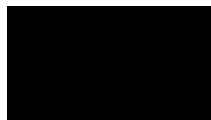

C01 - RAL 9005 BLACK

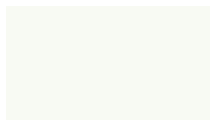

C02 - RAL 9010 PUREWHITE

CONTEMPORARY LACQUER / LACCATO CONTEMPORANEO

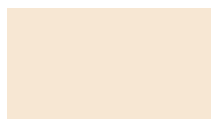

D01 - RAL 1013 PEARL WHITE



D02 - RAL 7047 TELEGREY 4



D03 - RAL 7030 STONE GREY



D19 - S7502 G DARK GREY



D21 - S1510Y80R POWDER PINK



D29 - S3060 Y60R RED ORANGE



D26 - S3560 Y80R CARMINE RED



D14 - RAL 3005 WINE RED



D30 - S3030 B PASTEL BLUE



D11 - RAL 7000 SQUIRREL GREY



D12 - RAL 7031 BLUEGREY



D25 - RAL 5011 STEEL BLUE



D15 - RAL 5020 OCEAN BLUE



D27 - S1050 Y10R MELON YELLOW



D28 - S2050 G90Y CAMPUS GREEN



D23 - S6020 G10Y DARK GREEN

Gebrüder Thonet Vienna GmbH
Prinz Eugen Straße 42
1040 Wien (AT)

www.gebruederthonetvienna.com

Offices of the trademarks' licensee
Production Furniture International S.p.A.
Via Foggia, 23/H
10152 Torino (TO) Italy

Phone: 0039 011 0133330 - info@gebruederthonetvienna.com