



CZECH

TECHNISCHES BLATT  
SCHEDA TECNICA  
DATA SHEET  
FICHE TECHNIQUE

# CZECH

DESIGN HERMANN CZECH, 1994



Stuhl aus Buchenbugholz mit oder ohne Armlehnen. Sitz aus Schichtholz oder gepolstert. In der lackierten Ausführung mit oder ohne FüÙe in Buche Natur verfügbar.

Sedia e poltroncina in faggio curvato, con seduta in multistrato o imbottita. La versione laccata è disponibile con o senza gambaleto in faggio naturale.

Bent beech-wood chair and armchair, with plywood or upholstered seat. The lacquered version is available with or without natural beech feet.

Chaise et petit fauteuil en hêtre cintré, avec assise en contreplaqué ou rembourrée; la version laquée est disponible avec ou sans les pieds en hêtre naturel.



**SDCZECLGN**

Dimensions mm.

height 850 | width 420 | depth 510



**PTCZECLGN**

Dimensions mm.

height 850 | width 550 | depth 510



**SDCZECTES**

Dimensions mm.

height 850 | width 420 | depth 510





**PTCZECTES**

Dimensions mm.

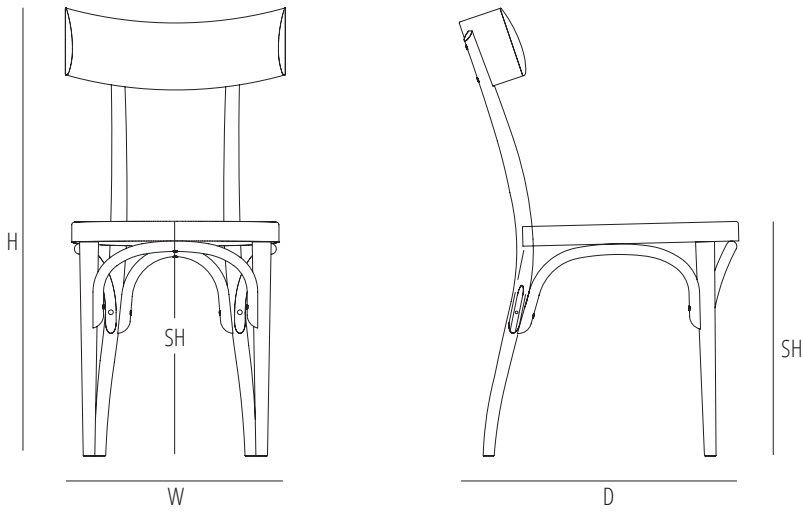
height 850 | width 550 | depth 510



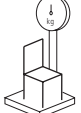
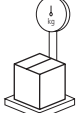
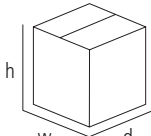

	H	W	D	SH	AH
mm	850	420	510	450	
inch	33,4	16,5	20,1	17,7	

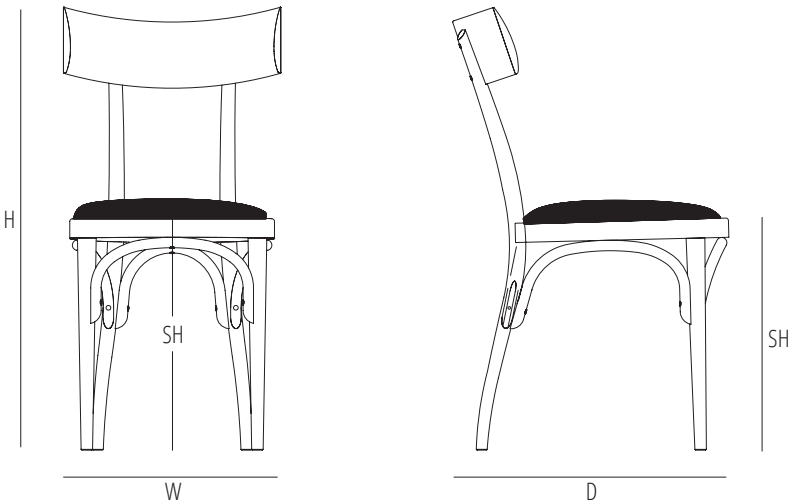
 1
  max. 2
  0,36
  4
  7
 
 mm - inch  
 h 960 - 37,7  
 w 620 - 24,4  
 d 600 - 23,6

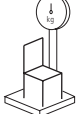
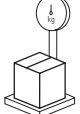
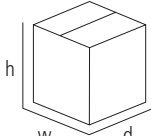

	H	W	D	SH	AH
mm	850	420	510	450	1 Pz/Pc: 50 cm. Linear x 140 cm h/width
inch	33,4	16,5	20,1	17,7	2 Pz/Pc: 50 cm. Linear x 140 cm h/width

 1
  max. 2
  0,36
  4
  7
 
 mm - inch  
 h 960 - 37,7  
 w 620 - 24,4  
 d 600 - 23,6

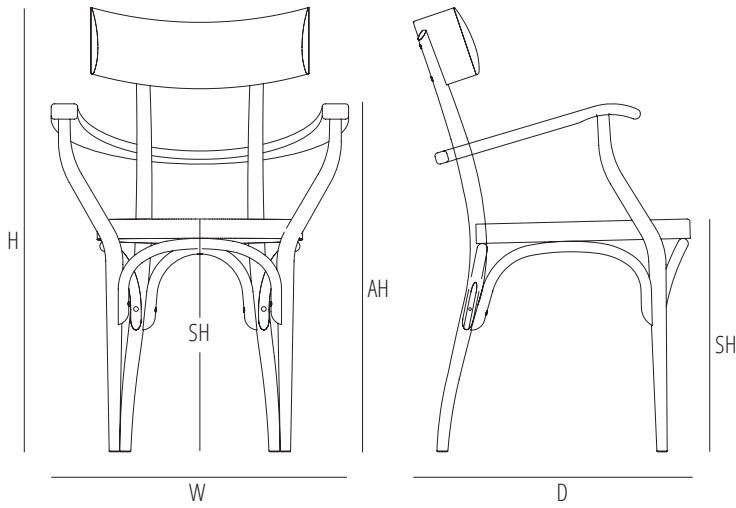

	H	W	D	SH	AH
mm	850	550	510	450	680
inch	33,4	21,6	20,1	17,7	26,7

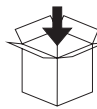

max. 1

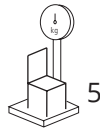
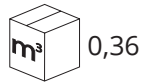

5

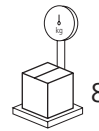

8

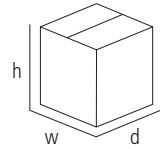

mm - inch  
h 960 - 37,7  
w 620 - 24,4  
d 600 - 23,6

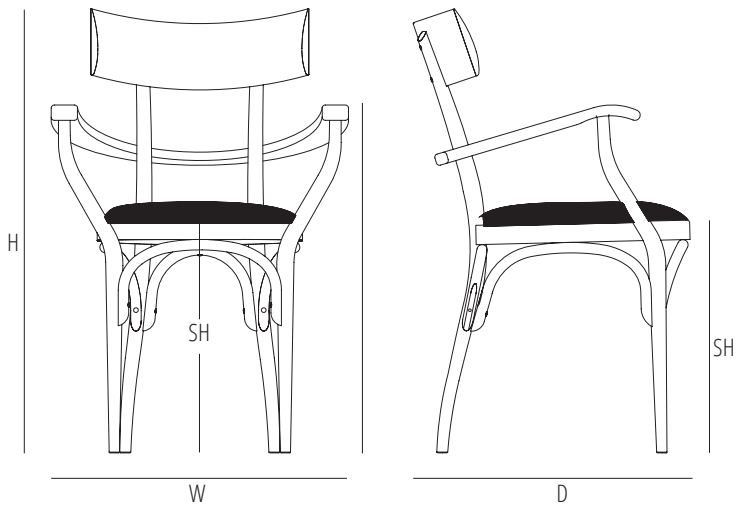

	H	W	D	SH	AH	
mm	850	550	510	450	680	1 Pz/Pc: 50 cm. Linear x 140 cm h/width
inch	33,4	21,6	20,1	17,7	26,7	2 Pz/Pc: 50 cm. Linear x 140 cm h/width

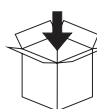

max. 1

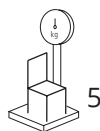
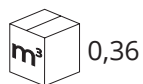

5

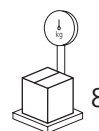

8

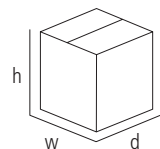

mm - inch  
h 960 - 37,7  
w 620 - 24,4  
d 600 - 23,6

Verfuegbare Ausfuehrungen  
 Finiture disponibili  
 Available finishes  
 Finitions disponibles



In der lackierten Ausfuehrung mit oder ohne FüÙe in Buche Natur verfuegbar (B01).  
 La versione laccata è disponibile con o senza gambaletto in faggio naturale (B01).  
 The lacquered version is available with or without natural beech feet (B01).  
 La version laquée est disponible avec ou sans les pieds en hêtre naturel (B01).

SOLID WOOD / ESSENZE NATURALI



B01 BEECH  
 B01 FAGGIO

STAINS / TINTI



B03 DARK WALNUT  
 B03 NOCE SCURO



B04 WENGÈ  
 B04 WENGÈ



B05 BEECH GLOSS 0  
 B05 FAGGIO GLOSS 0

CLASSIC LACQUER / LACCATO CLASSICO



C01 - RAL 9005 BLACK

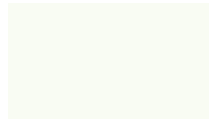

C02 - RAL 9010 PURE WHITE

CONTEMPORARY LACQUER / LACCATO CONTEMPORANEO

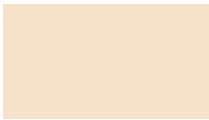

D01 - RAL 1013 PEARL WHITE



D02 - RAL 7047 TELEGREY 4



D03 - RAL 7030 STONE GREY



D19 - S7502 G DARK GREY



D21 - S1510 Y80R POWDER PINK



D20 - S2570 Y60R ORANGE



D10 - RAL 3000 FLAME RED



D14 - RAL 3005 WINE RED



D22 - S1515 R90B LIGHT BLUE



D11 - RAL 7000 SQUIRREL GREY



D12 - RAL 7031 BLUE GREY



D25 - RAL 5011 STEEL BLUE



D15 - RAL 5020 OCEAN BLUE



D24 - S2070 Y10R YELLOW OCRE



D07 - RAL 1027 CURRYYELLOW



D23 - S6020 G10Y DARK GREEN

Gebrüder Thonet Vienna GmbH  
Prinz Eugen Straße 42  
1040 Wien (AT)

**[www.gebruederthonetvienna.com](http://www.gebruederthonetvienna.com)**

Offices of the trademarks' licensee  
Production Furniture International S.p.A.  
Via Foggia, 23/H  
10152 Torino (TO) Italy

Phone: 0039 011 0133330 - [info@gebruederthonetvienna.com](mailto:info@gebruederthonetvienna.com)