



RADETZKY

TECHNISCHES BLATT
SCHEDA TECNICA
DATA SHEET
FICHE TECHNIQUE

RADETZKY

DESIGN MICHELE DE LUCCHI, 2015



Stuhl aus Buchenbugholz mit Sitz aus Schichtholz oder gepolstert.

Sedia in faggio curvato. Seduta in multistrato o imbottita.

Bent beech-wood chair. Plywood or upholstered seat.

Chaise en hêtre cintré. Assise en contreplaqué ou rembourrée.



SDRADELGN

Dimensions mm.

height 800 | width 520 | depth 500





SDRADETES

Dimensions mm.

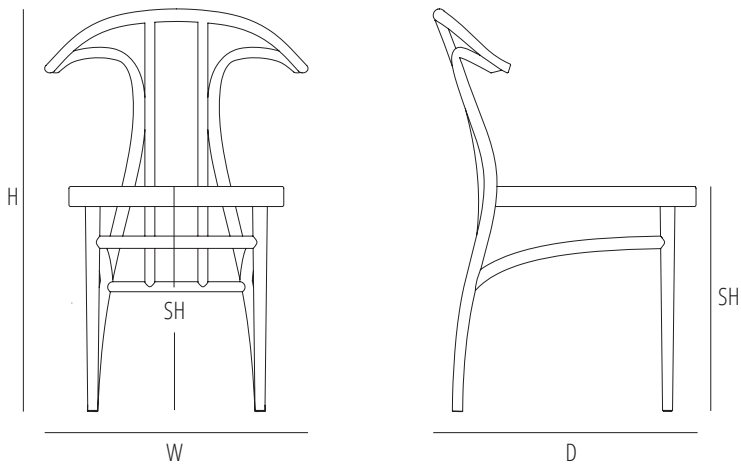
height 800 | width 520 | depth 500



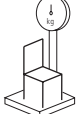
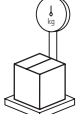
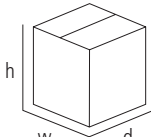

	H	W	D	SH	AH
mm	800	520	500	450	
inch	31,4	20,4	19,6	17,7	

 1
  max. 2
  0,36
  5
  8
 

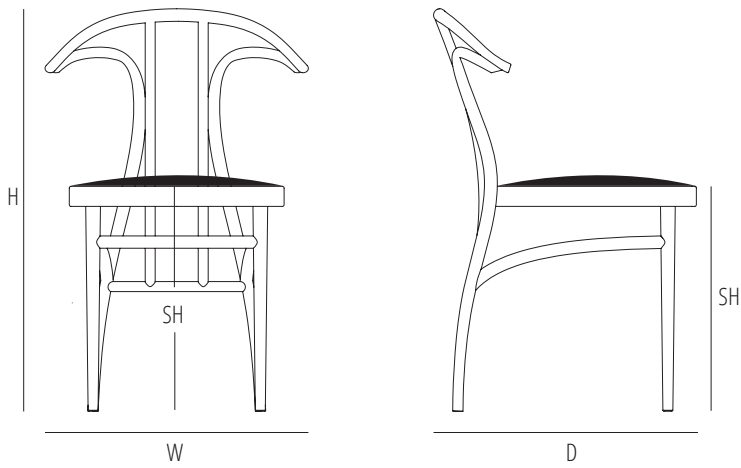
mm - inch
 h 960 - 37,7
 w 620 - 24,4
 d 600 - 23,6

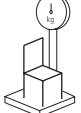
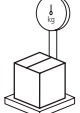
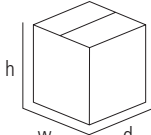

	H	W	D	SH	AH
mm	800	520	500	450	1 Pz/Pc: 50 cm. Linear x 140 cm h/width
inch	31,4	20,4	19,6	17,7	2 Pz/Pc: 50 cm. Linear x 140 cm h/width

 1
  max. 2
  0,36
  5
  8
 

mm - inch
 h 960 - 37,7
 w 620 - 24,4
 d 600 - 23,6

Verfuegbare Ausfuehrungen
Finiture disponibili
Available finishes
Finitions disponibles

SOLID WOOD / ESSENZE NATURALI



B01 BEECH
B01 FAGGIO

STAINS / TINTI



B03 DARK WALNUT
B03 NOCE SCURO



B04 WENGÈ
B04 WENGÈ



B05 BEECH GLOSS O
B05 FAGGIO GLOSS O

CLASSIC LACQUER / LACCATO CLASSICO



C01 - RAL 9005 BLACK

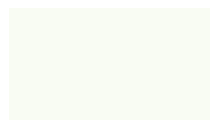

C02 - RAL 9010 PURE WHITE

CONTEMPORARY LACQUER / LACCATO CONTEMPORANEO



D01 - RAL 1013 PEARL WHITE



D02 - RAL 7047 TELEGREY 4



D03 - RAL 7030 STONE GREY



D19 - S7502 G DARK GREY



D21 - S1510 Y80R POWDER PINK



D20 - S2570 Y60R ORANGE



D10 - RAL 3000 FLAME RED



D14 - RAL 3005 WINE RED



D22 - S1515 R90B LIGHT BLUE



D11 - RAL 7000 SQUIRREL GREY



D12 - RAL 7031 BLUE GREY



D25 - RAL 5011 STEEL BLUE



D15 - RAL 5020 OCEAN BLUE



D24 - S2070 Y10R YELLOW OCRE



D07 - RAL 1027 CURRY YELLOW



D23 - S6020 G10Y DARK GREEN

Gebrüder Thonet Vienna GmbH
Prinz Eugen Straße 42
1040 Wien (AT)

www.gebruederthonetvienna.com

Offices of the trademarks' licensee
Production Furniture International S.p.A.
Via Foggia, 23/H
10152 Torino (TO) Italy

Phone: 0039 011 0133330 - info@gebruederthonetvienna.com