

HOT

DESIGN GEBRÜDER THONET VIENNA GmbH (GTV), 2000



Stuhl mit Gestell aus verchromtem Stahl. Sitz und Rückenlehne aus Schichtholz.

Sedia con struttura in acciaio cromato. Seduta e schienale in multistrato di faggio.

Chair with structure in chromed steel. Plywood seat and backrest.

Chaise avec structure en acier chromé. Assise et dossier en contreplaqué.

Stuhl mit Gestell aus verchromtem Stahl. Gepolsterte Sitz und Rückenlehne.

Sedia con struttura in acciaio cromato. Seduta e schienale imbottiti.

Chair with structure in chromed steel. Upholstered seat and backrest.

Chaise avec structure en acier chromé. Assise et dossier rembourrés.

Armstuhl mit Gestell aus verchromtem Stahl. Armlehnen aus Massivholz. Sitz und Rückenlehne aus Schichtholz.

Poltroncina con struttura in acciaio. Braccioli in legno massello. Seduta e schienale in multistrato di faggio.

Chair with arms with structure in chromed steel. Arms in solid wood. Plywood seat and backrest.

Chaise avec accoudoirs avec structure en acier chromé. Accoudoirs en bois massif. Assise et dossier en contreplaqué.

Armstuhl mit Gestell aus verchromtem Stahl. Armlehnen aus Massivholz. Gepolsterte Sitz und Rückenlehne.

Poltroncina con struttura in acciaio cromato. Braccioli in legno massello. Seduta e schienale imbottiti.

Chair with arms with structure in chromed steel. Arms in solid wood. Upholstered seat and backrest.

Chaise avec accoudoirs avec structure en acier chromé. Accoudoirs en bois massif. Assise et dossier rembourrés.



SDHOTLGN

Dimensions mm.
height 900 | width 440 | depth 480



SDHOTTES

Dimensions mm.
height 900 | width 440 | depth 480



PTHOTLGN

Dimensions mm.
height 900 | width 440 | depth 480



PTHOTTES

Dimensions mm.
height 900 | width 440 | depth 480

	mm	inch
H	900	35,4
L	440	17,3
P	480	18,8
Hs	450	17,7
Hb		

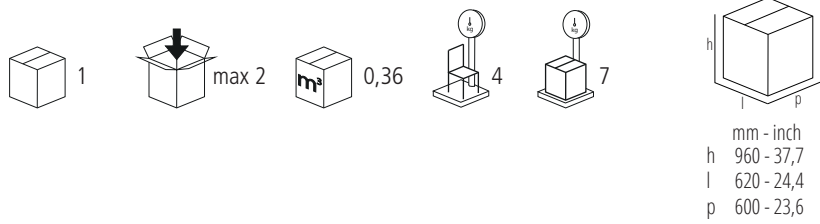
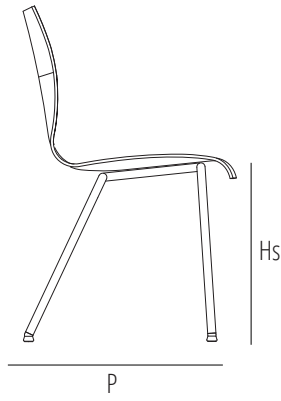
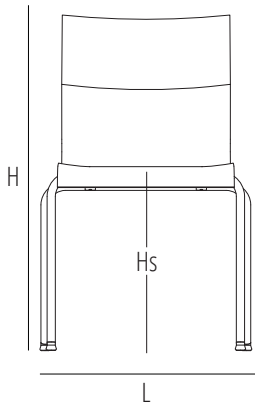

	mm	inch
H	900	35,4
L	440	17,3
P	480	18,8
Hs	450	17,7
Hb		

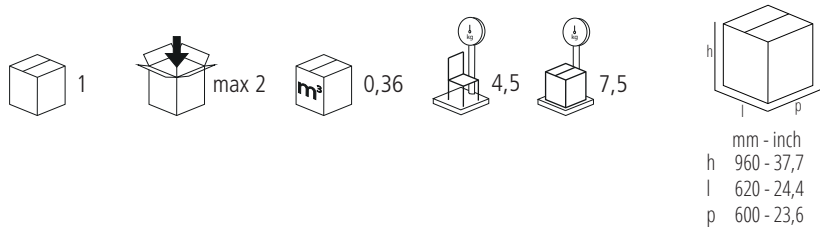
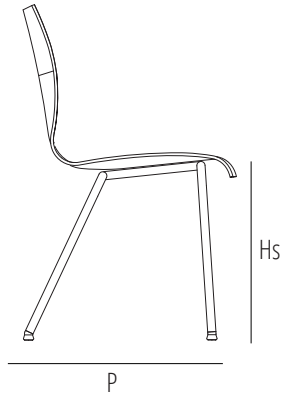
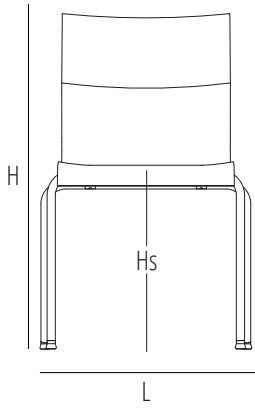

	mm	inch
H	900	35,4
L	440	17,3
P	480	18,8
Hs	450	17,7
Hb		

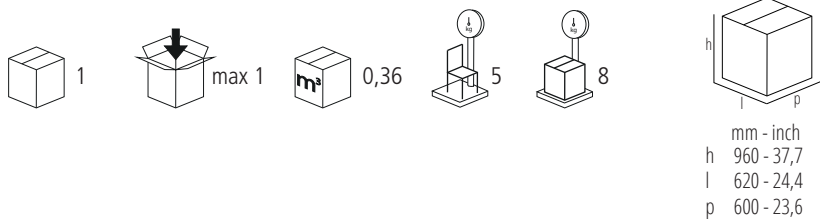
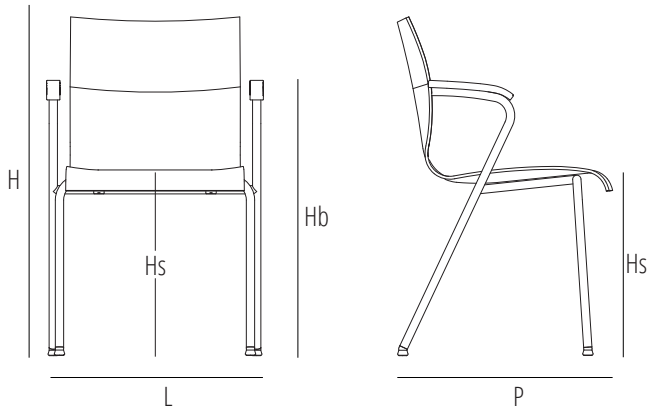

	mm	inch
H	900	35,4
L	440	17,3
P	480	18,8
Hs	450	17,7
Hb		

