



MOS

TECHNISCHES BLATT
SCHEMA TECNICA
DATA SHEET
FICHE TECHNIQUE

MOS

DESIGN GAMFRATESI, 2019



Sitzbank mit dampfgebogenem Buchenholzgestell und eingesetztem Wiener Geflecht. Regale aus offenporigem, lackiertem Eschefurnier. Gepolsterter Sitz mit abnehmbarem Bezug. Messing-Füßen.

Panca con struttura in faggio curvato a vapore e inserti in paglia di Vienna. Ripiani in impiallacciato in frassino verniciato a poro aperto. Seduta imbottita sfoderabile. Puntali in ottone.

Bench with bent beech-wood frame and woven cane inserts. Open-pore painted shelves in ash veneer. Upholstered seat with removable cover. Brass feet.

Banc avec structure en hêtre cintré et inserts en paille de Vienne. Étagères en plaqué frêne teinté à pores ouverts. Assise rembourrée déhoussable. Pieds en laiton.





PCMOSGTEP

Dimensions mm.

height 440 | width 1360 | depth 400

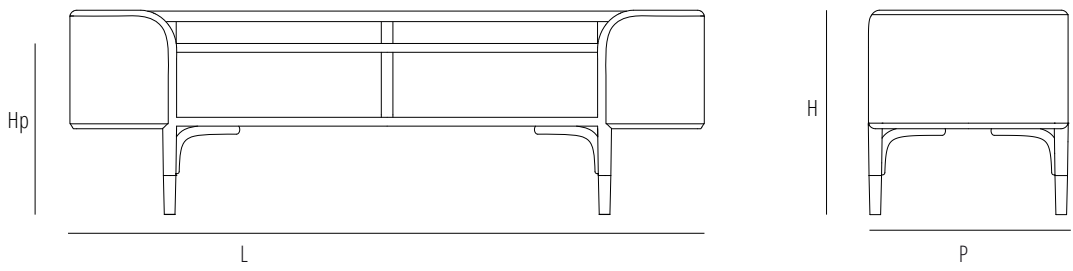
	mm	inch
H	440	17,3
L	1360	53,5
P	400	15,7
Hp	370	14,5
Hb		



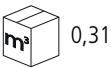
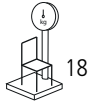
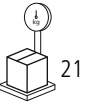
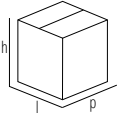

 1
  max 1
  0,31
  18
  21
 

mm - inch
 h 470 - 18,5
 l 1420 - 56
 p 470 - 18,5

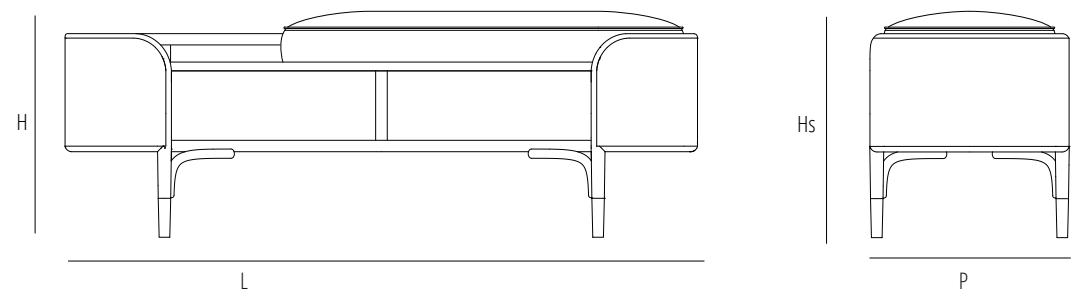
	mm	inch
H	440	17,3
L	1360	53,5
P	400	15,7
Hs	440	17,3
Hb		

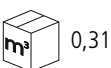
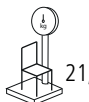
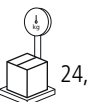
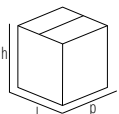

 1
  max 1
  0,31
  21,5
  24,5
 

mm - inch
 h 470 - 18,5
 l 1420 - 56
 p 470 - 18,5

	mm	inch
H	440	17,3
L	1360	53,5
P	400	15,7
Hs	440	17,3
Hb		

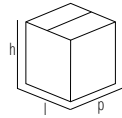
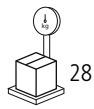
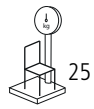
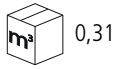
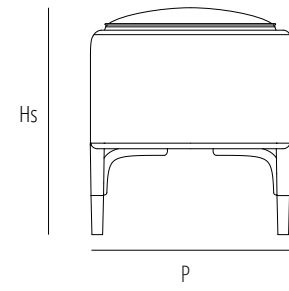
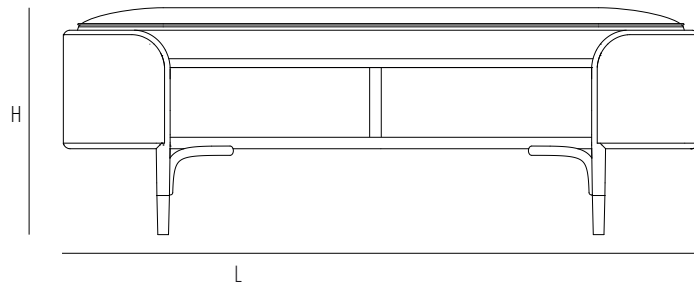

mm - inch
h 470 - 18,5
l 1420 - 56
p 470 - 18,5

Verfuegbare Ausfuehrungen

Finiture disponibili

Available finishes

Finitions disponibles

WOOD



B01 FAGGIO NATURALE

CLASSIC

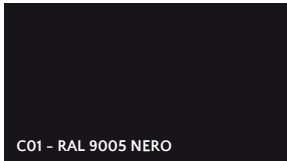

C01 - RAL 9005 NERO

Gebrüder Thonet Vienna GmbH
Prinz Eugen Straße 42
1040 Wien (AT)

www.gebruederthonetvienna.com

Offices of the trademarks' licensee
Production Furniture International S.p.A.
Via Foggia, 23/H
10152 Torino (TO) Italy

Phone: 0039 011 0133330 - info@gebruederthonetvienna.com