



AMPLE

TECHNISCHES BLATT
SCHEMA TECNICA
DATA SHEET
FICHE TECHNIQUE

AMPLE

DESIGN NICHETTO STUDIO, 2023



Stuhl mit rohrförmigem Metallgestell und Sitz und Rückenlehne aus Esche. Der Sitz ist in Holz oder gepolstert erhältlich.

Sedia con struttura in tubolare metallico e con seduta e schienale in frassino. La seduta è disponibile in legno o imbottita.

Chair with tubular metal frame and ash seat and back. The seat is available in wood or upholstered.

Chaise avec cadre métallique tubulaire, siège et dossier en frêne. Le siège est disponible avec une assise en bois ou rembourrée.

Silla con estructura de metal tubular y asiento y respaldo de fresno. El asiento está disponible en madera o tapizado.



SDAMPLGN

Dimensions mm.
height 770 | width 510 | depth 500



SDAMPLTES

Dimensions mm.
height 770 | width 510 | depth 500

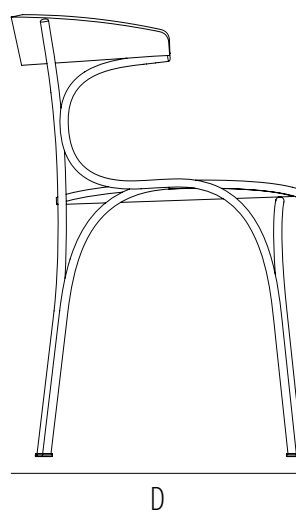
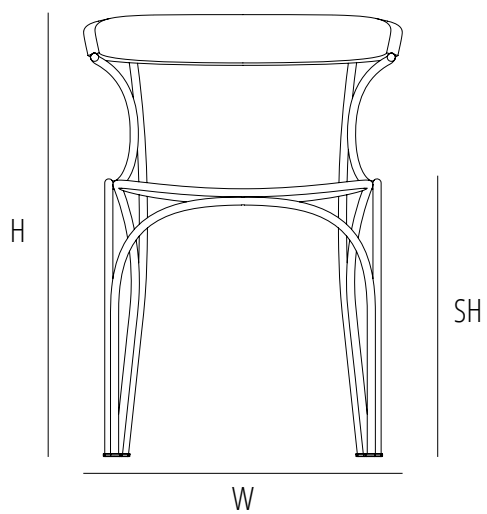

	H	W	D	SH	AH
mm	770	510	500	470	
inch	30,3	20	19,6	18,5	

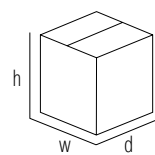
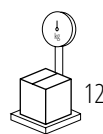
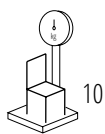
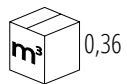

mm - inch
 h 960 - 37,7
 w 620 - 24,4
 d 600 - 23,6

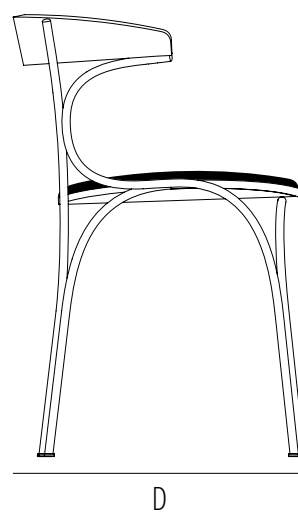
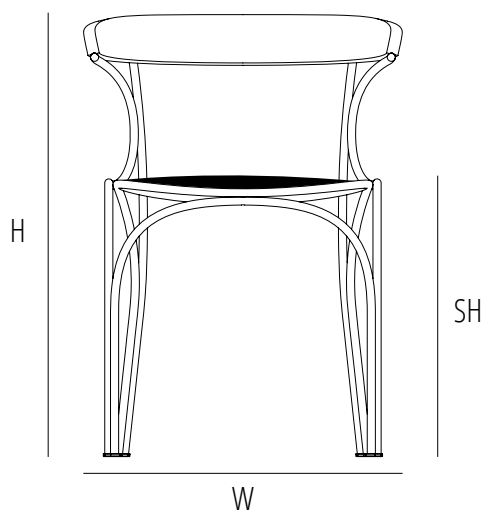

	H	W	D	SH	AH	
mm	770	510	500	470		1 Pz/Pc: 60 cm. Linear x 140 cm h/width
inch	29,9	20	19,6	18,5		2 Pz/Pc: 60 cm. Linear x 140 cm h/width

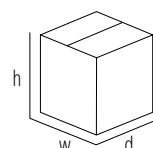
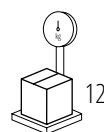
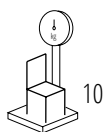
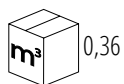
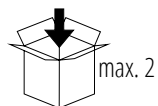

mm - inch
 h 960 - 37,7
 w 620 - 24,4
 d 600 - 23,6

Verfuegbare Ausfuehrungen
Finiture disponibili
Available finishes
Finitions disponibles

STRUCTURE

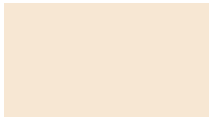

D01 - RAL 1013 PEARL WHITE

BACKREST



B07 ASH
B07 FRASSINO

STRUCTURE



D31 - RAL 7022 UMBRA GREY

BACKREST



B03 DARK WALNUT
B03 NOCE SCURO

STRUCTURE



D32 - RAL 6003 OLIVE GREEN

BACKREST



ASH WOOD STAINED IN RAL 6003
FRASSINO TINTO RAL 6003

Gebrüder Thonet Vienna GmbH
Prinz Eugen Straße 42
1040 Wien (AT)

www.gebruederthonetvienna.com

Offices of the trademarks' licensee
Production Furniture International S.p.A.
Via Foggia, 23/H
10152 Torino (TO) Italy

Phone: 0039 011 0133330 - info@gebruederthonetvienna.com