



AMPLE

TECHNISCHES BLATT
SCHEMA TECNICA
DATA SHEET
FICHE TECHNIQUE

AMPLE

DESIGN NICHETTO STUDIO, 2023



Stuhl für drinnen und draußen.

Die Version für den Innenbereich besteht aus einem Gestell aus Metallrohren und einer Rückenlehne aus Eschenholz. Der Sitz ist in Eschenholz oder gepolstert erhältlich. Die Version für den Außenbereich besteht aus einem Gestell aus Eisenrohren mit Sitz und Rückenlehne aus Iroko-Holz.

Sedia realizzata per ambienti indoor e outdoor.

La versione indoor è realizzata con struttura in tubolare metallico e schienale in legno di frassino. Il sedile è disponibile in legno di frassino o imbottito. La versione da esterno è realizzata con struttura in tubolare di ferro e seduta e schienale in legno Iroko.

Indoor and outdoor chair. The indoor version is made with tubular metal frame and ash wood backrest. The seat is available in ash wood or upholstered. The outdoor version is made with tubular iron frame and Iroko wood seat and back.

Fauteuil d'intérieur et d'extérieur. La version d'intérieur est fabriquée avec un cadre métallique tubulaire et un dossier en bois de frêne. Le siège est disponible en bois de frêne ou en version matelassée. La version d'extérieur est fabriquée avec un cadre en fer tubulaire, un siège et un dossier en bois Iroko.

Silla para interior y exterior. La versión de interior está fabricada con estructura de metal tubular y respaldo de madera de fresno. El asiento está disponible en madera de fresno o tapizado. La versión de exterior está fabricada con estructura de hierro tubular y asiento y respaldo de madera Iroko.



SDAMPLGN

Dimensions mm.
height 770 | width 510 | depth 500



SDAMPLTES

Dimensions mm.
height 770 | width 510 | depth 500

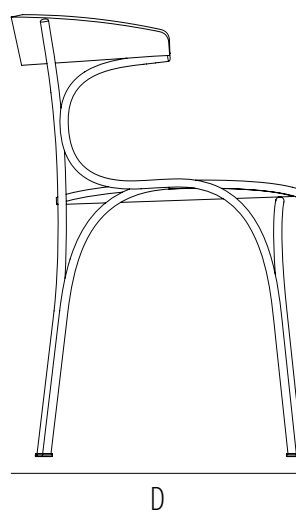
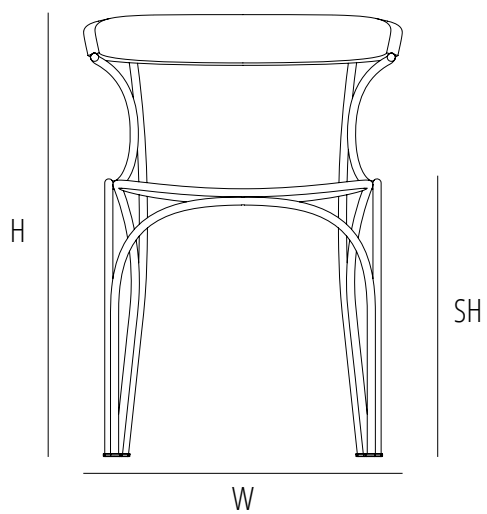

	H	W	D	SH	AH
mm	770	510	500	470	
inch	30,3	20	19,6	18,5	

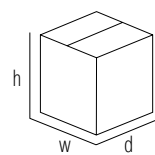
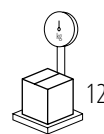
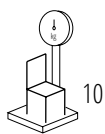
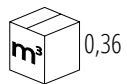

mm - inch
 h 960 - 37,7
 w 620 - 24,4
 d 600 - 23,6

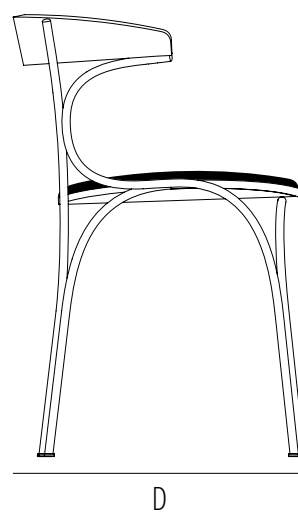
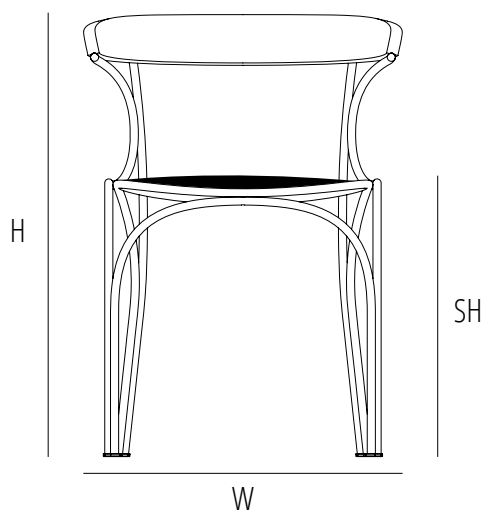

	H	W	D	SH	AH	
mm	770	510	500	470		1 Pz/Pc: 60 cm. Linear x 140 cm h/width
inch	29,9	20	19,6	18,5		2 Pz/Pc: 60 cm. Linear x 140 cm h/width

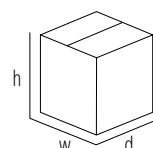
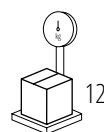
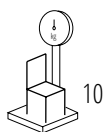
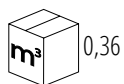
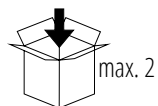

mm - inch
 h 960 - 37,7
 w 620 - 24,4
 d 600 - 23,6

Verfuegbare Ausfuehrungen
Finiture disponibili
Available finishes
Finitions disponibles

STRUCTURE

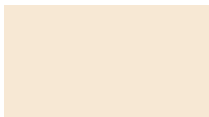

D01 - RAL 1013 PEARL WHITE

BACKREST



B07 ASH
B07 FRASSINO

BACKREST OUTDOOR



IROKO

STRUCTURE



D31 - RAL 7022 UMBRA GREY

BACKREST



B03 DARK WALNUT
B03 NOCE SCURO

BACKREST OUTDOOR



IROKO

STRUCTURE



D32 - RAL 6003 OLIVE GREEN

BACKREST



ASH WOOD STAINED IN RAL 6003
FRASSINO TINTO RAL 6003

BACKREST OUTDOOR



IROKO

Gebrüder Thonet Vienna GmbH
Prinz Eugen Straße 42
1040 Wien (AT)

www.gebruederthonetvienna.com

Offices of the trademarks' licensee
Production Furniture International S.p.A.
Via Foggia, 23/H
10152 Torino (TO) Italy

Phone: 0039 011 0133330 - info@gebruederthonetvienna.com