



CIRQUE

TECHNISCHES BLATT
SCHEMA TECNICA
DATA SHEET
FICHE TECHNIQUE

CIRQUE

DESIGN MARTINO GAMPER, 2015



Hocker aus Buchenbugholz in zwei Höhen erhältlich. Barhocker auch mit Rückenlehne erhältlich. Sitz aus Schichtholz oder gepolstert.

Sgabello in faggio curvato disponibile in due altezze. Lo sgabello alto è disponibile anche con schienale. Seduta imbottita oppure in multistrato.

Sgabello in faggio curvato disponibile in due altezze. Lo sgabello alto è disponibile anche con schienale. Seduta imbottita oppure in multistrato.

Tabouret en hêtre cintré disponibles en deux hauteurs. Le tabouret bar est également disponible avec un dossier. Assise disponible rembourrée ou en contreplaqué.

Taburete en haya curvada disponible en dos alturas. El taburete alto también está disponible con respaldo. Asiento tapizado o en multicapa.



GCIRLLGN

SGCIRLTES

Dimensions mm.
height 970 | width 440 | depth 440



SGCIRMLGN

SGCIRMTES

Dimensions mm.
height 780 | width 440 | depth 440



SGCIRSLGN

SGCIRSTES

Dimensions mm.
height 470 | width 410 | depth 410

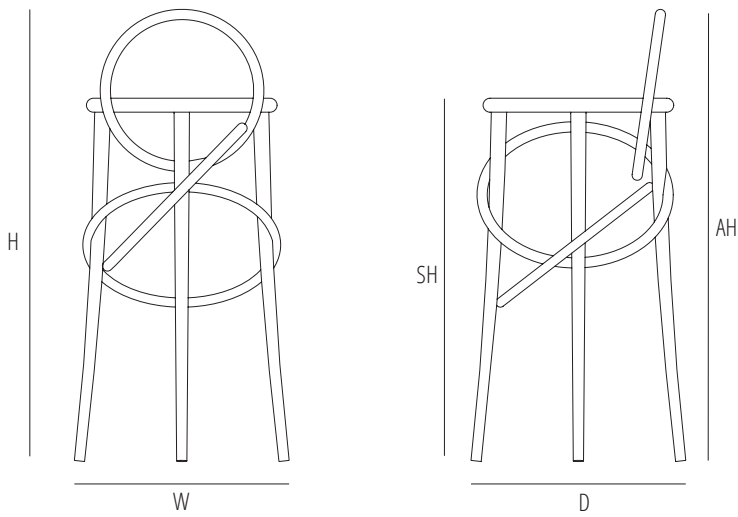

	H	W	D	SH	AH
mm	970	440	440	780	970
inch	38,1	17,3	17,3	30,7	38,1

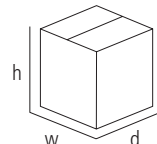
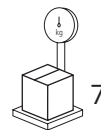
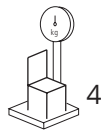
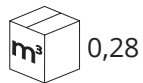
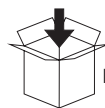

mm - inch
h 1000 - 39,3
w 500 - 19,6
d 550 - 21,6

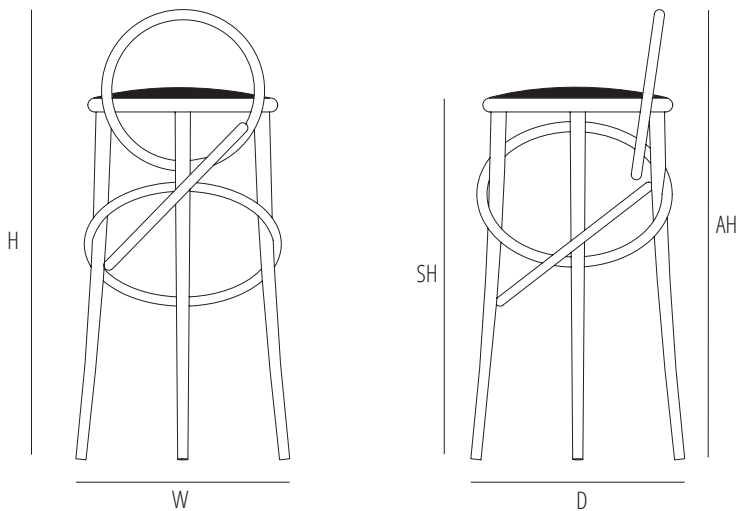

	H	W	D	SH	AH	
mm	970	440	440	780	970	1 Pz/Pc: 40 cm. Linear x 140 cm h/width
inch	38,1	17,3	17,3	30,7	38,1	2 Pz/Pc: 40 cm. Linear x 140 cm h/width

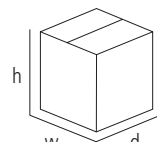
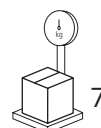
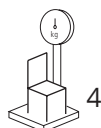
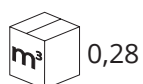
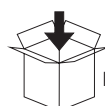

mm - inch
h 1000 - 39,3
w 500 - 19,6
d 550 - 21,6

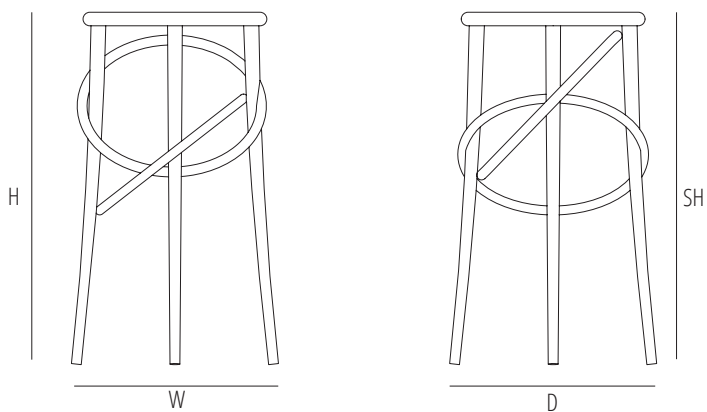

	H	W	D	SH	AH
mm	780	440	440	780	
inch	30,7	17,3	17,3	30,7	

1
 max. 1
 0,28
 4
 7

mm - inch
h 1000 - 39,3
w 500 - 19,6
d 550 - 21,6

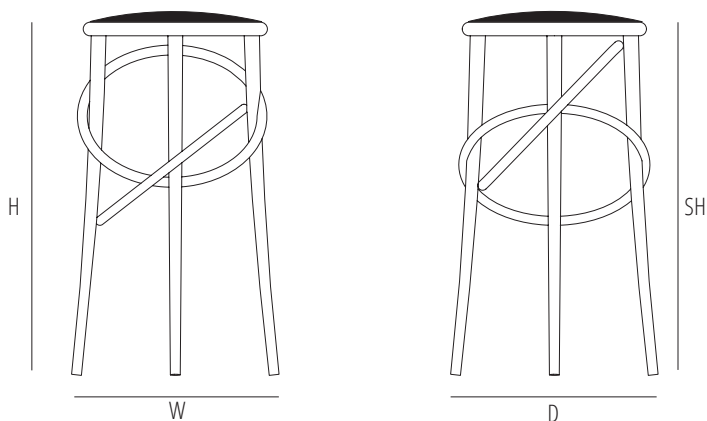

	H	W	D	SH	AH
mm	780	440	440	780	1 Pz/Pc: 40 cm. Linear x 140 cm h/width
inch	30,7	17,3	17,3	30,7	2 Pz/Pc: 40 cm. Linear x 140 cm h/width

1
 max. 1
 0,28
 4
 7

mm - inch
h 1000 - 39,3
w 500 - 19,6
d 550 - 21,6

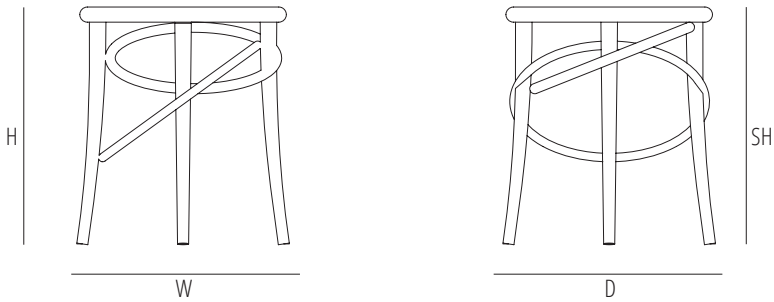

	H	W	D	SH	AH
mm	470	410	410	470	
inch	18,5	16,1	16,1	18,5	

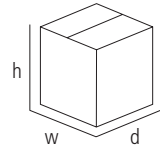
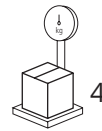
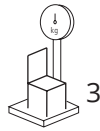
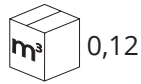

mm - inch
h 540 - 21,2
w 460 - 18,1
d 460 - 18,1

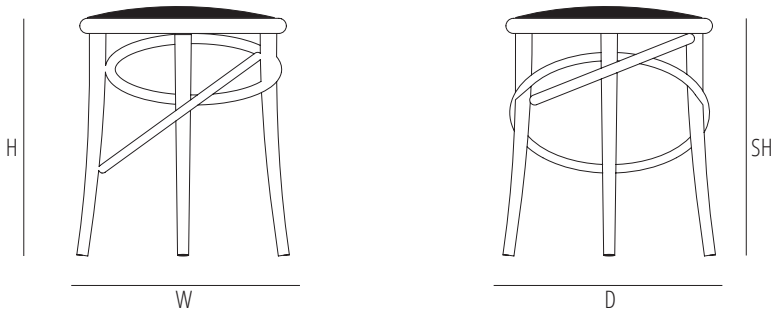

	H	W	D	SH	AH
mm	470	410	410	470	
inch	18,5	16,1	16,1	18,5	

1 Pz/Pc: 40 cm. Linear x 140 cm h/width
2 Pz/Pc: 40 cm. Linear x 140 cm h/width

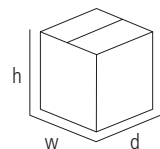
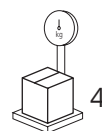
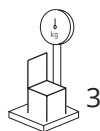
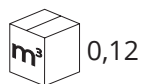

mm - inch
h 540 - 21,2
w 460 - 18,1
d 460 - 18,1

Verfuegbare Ausfuehrungen
Finiture disponibili
Available finishes
Finitions disponibles

TWO TONE

SOLID WOOD / ESSENZE NATURALI + STAINS / TINTI



B01 BEECH
B01 FAGGIO



B03 DARK WALNUT
B03 NOCE SCURO



B03 DARK WALNUT
B03 NOCE SCURO



B01 BEECH
B01 FAGGIO

CLASSIC LACQUER / LACCATO CLASSICO



C01 - RAL 9005 BLACK

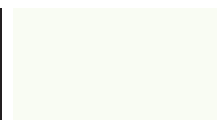

C02 - RAL 9010 PURE WHITE

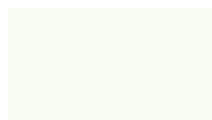

C02 - RAL 9010 PURE WHITE



C01 - RAL 9005 BLACK

Verfuegbare Ausfuehrungen
Finiture disponibili
Available finishes
Finitions disponibles

ONE TONE

SOLID WOOD / ESSENZE NATURALI

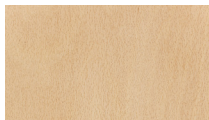

B01 BEECH
B01 FAGGIO

STAINS / TINTI



B03 DARK WALNUT
B03 NOCE SCURO



B04 WENGÈ
B04 WENGÈ



B08 BEECH-WOOD STAINED IN NOCE CANALETTO
B08 FAGGIO TINTO NOCE CANALETTO

CLASSIC LACQUER / LACCATO CLASSICO

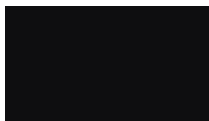

C01 - RAL 9005 BLACK

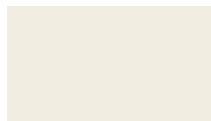

C02 - RAL 9010 PUREWHITE

CONTEMPORARY LACQUER / LACCATO CONTEMPORANEO



D01 - RAL 1013 PEARL WHITE



D03 - RAL 7030 STONE GREY



D11 - RAL 7000 SQUIRREL GREY



D19 - S7502 G DARK GREY



D15 - RAL 5020 OCEAN BLUE



D23 - S6020 G10Y DARK GREEN



D29 - S3060 Y60R RED ORANGE



D14 - RAL 3005 WINE RED

Gebrüder Thonet Vienna GmbH
Prinz Eugen Straße 42
1040 Wien (AT)

www.gebruederthonetvienna.com

Offices of the trademarks' licensee
Production Furniture International S.p.A.
Via Foggia, 23/H
10152 Torino (TO) Italy

Phone: 0039 011 0133330 - info@gebruederthonetvienna.com