



MON ÎLE

TECHNISCHES BLATT  
SCHEMA TECNICA  
DATA SHEET  
FICHE TECHNIQUE

# MON ÎLE

DESIGN SERGIO BICEGO, 2024



Polstermöbelfamilie, bestehend aus einem modularen Sofa und einem Rundsessel. Die Sitzfläche ist gepolstert, die Rückenlehne gepolstert oder aus geflochtenem Schilfrohr mit massivem Eschenholzrahmen. Das Sofa ist in verschiedenen Kombinationen erhältlich. Ergänzt wird die Kollektion durch 2 Couchtische aus Esche mit Rohrgeflecht.

Famiglia di imbottiti composta da un divano modulare e una poltrona lounge dalla forma rotonda. Il sedile è imbottito e lo schienale è disponibile imbottito o in paglia di Vienna con struttura in massello di frassino. Il divano è disponibile in molteplici combinazioni. Completano la collezione 2 tavolini in frassino con inserti in paglia di Vienna.

Family of upholstered furniture consisting of a modular sofa and a round-shaped lounge chair. The seat is upholstered and the backrest is available upholstered or in woven cane with a solid ash wood frame. The sofa is available in multiple combinations. The collection is completed by 2 ash coffee tables with woven cane inserts.

Famille de meubles matelassés composée d'un canapé modulaire et d'une chaise longue de forme ronde. Le siège est rembourré et le dossier est disponible en version matelassée ou en paille de Vienne avec un cadre en bois de frêne massif. Le canapé est disponible en plusieurs combinaisons. La collection est complétée par 2 tables basses en frêne avec des inserts en paille de Vienne.

Familia de muebles tapizados compuesta por un sofá modular y un sillón de forma redonda. El asiento está tapizado y el respaldo está disponible tapizado o en caña tejida con armazón de madera maciza de fresno. El sofá está disponible en múltiples combinaciones. La colección se completa con 2 mesas de centro de fresno con inserciones de caña tejida.



**DMM125TES**  
Dimensions mm.  
height 420 | width 1250 | depth 950



**DMM155TES**  
Dimensions mm.  
height 420 | width 1550 | depth 950



**DMM160TDX**  
Dimensions mm.  
height 420 | width 1600 | depth 950



**DMM160TSX**  
Dimensions mm.  
height 420 | width 1600 | depth 950



**DMM190TDX**  
Dimensions mm.  
height 420 | width 1900 | depth 950



**DMM190TSX**  
Dimensions mm.  
height 420 | width 1900 | depth 950



**DMM220TDX**  
Dimensions mm.  
height 420 | width 2200 | depth 950



**DMM220TSX**  
Dimensions mm.  
height 420 | width 2200 | depth 950



**DMM255TES**  
Dimensions mm.  
height 420 | width 2550 | depth 950



**DMM225TES**  
Dimensions mm.  
height 420 | width 2250 | depth 950



**PLMONITES**  
Dimensions mm.  
height 420 | width 1000 | depth 1000



**SCH120TES**  
Dimensions mm.  
height 460 | width 1200 | depth 200



**SCH090TES**  
Dimensions mm.  
height 460 | width 900 | depth 200



**SCHLDXTES**  
Dimensions mm.  
height 460 | width 950 | depth 680



**SCHLSXTES**  
Dimensions mm.  
height 460 | width 950 | depth 680



**SCHANGTES**  
Dimensions mm.  
height 460 | width 680 | depth 680



**SCH120PGL**  
Dimensions mm.  
height 460 | width 1200 | depth 200



**SCH090PGL**  
Dimensions mm.  
height 460 | width 950 | depth 200



**SCHLDXTES**  
Dimensions mm.  
height 460 | width 950 | depth 680



**SCHLSXTES**  
Dimensions mm.  
height 460 | width 950 | depth 680



**SCHANGTES**  
Dimensions mm.  
height 460 | width 680 | depth 680



**TVMON2PGL**  
Dimensions mm.  
height 4705 | width 650 | depth 550



**TVMON1PGL**  
Dimensions mm.  
height 340 | width 950 | depth 550



**CUL105TES**  
Dimensions mm.  
height 580 | width 1050 | depth 200



**CUL075TES**  
Dimensions mm.  
height 580 | width 750 | depth 200



**CUL062TES**  
Dimensions mm.  
height 480 | width 620 | depth 120

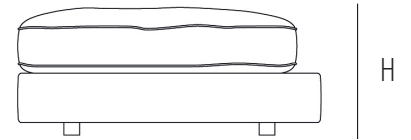
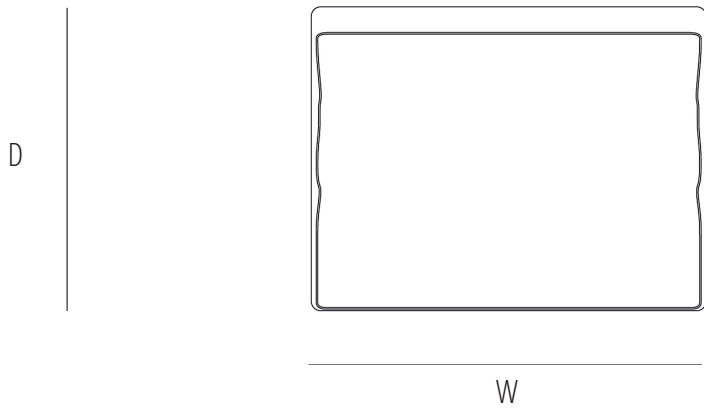

	H	W	D	SH	AH
mm	420	1250	950	420	
inch	16,5	49,2	37,4	16,5	

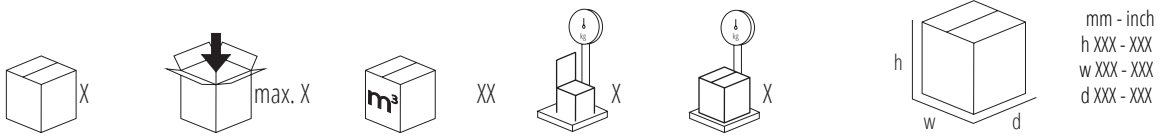

mm - inch  
 h XXX - XXX  
 w XXX - XXX  
 d XXX - XXX

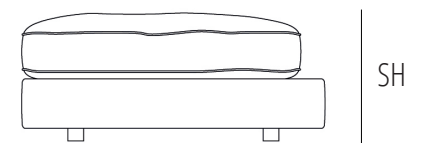
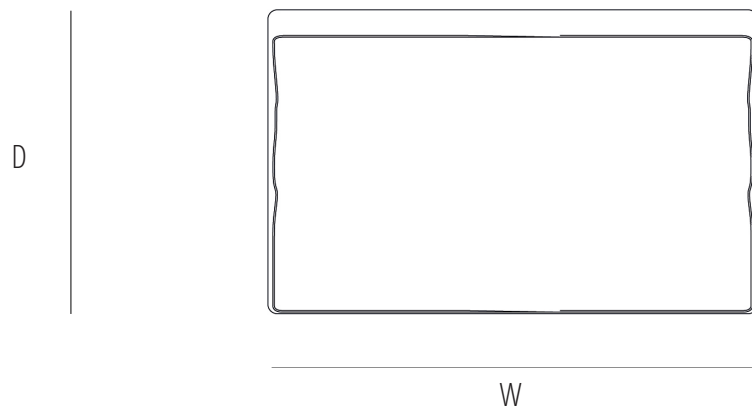

	H	W	D	SH	AH
mm	420	1550	950	420	
inch	16,5	61	37,4	16,5	

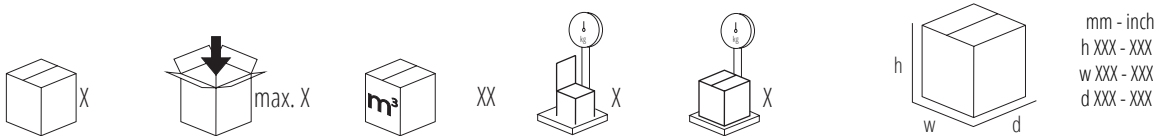

mm - inch  
 h XXX - XXX  
 w XXX - XXX  
 d XXX - XXX

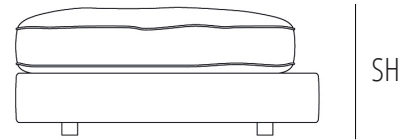
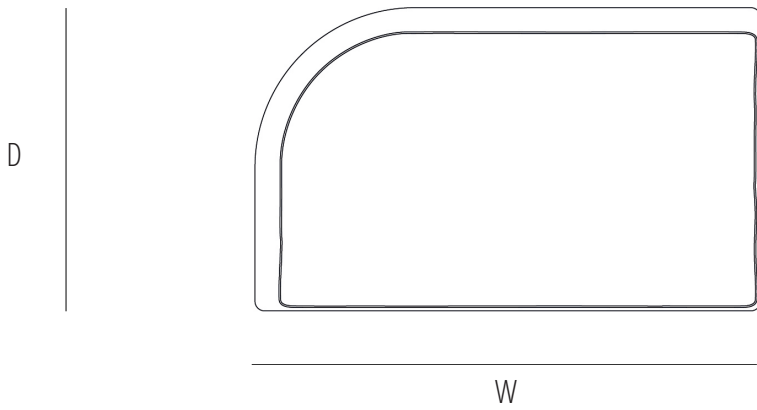

	H	W	D	SH	AH
mm	420	1600	950	420	
inch	16,5	62,9	37,4	16,5	

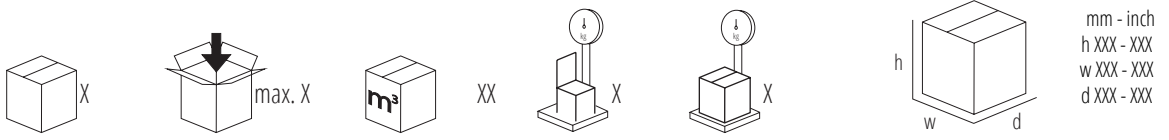

mm - inch  
 h XXX - XXX  
 w XXX - XXX  
 d XXX - XXX

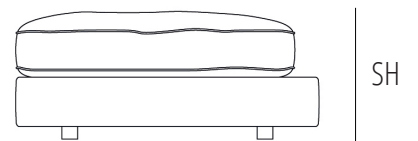
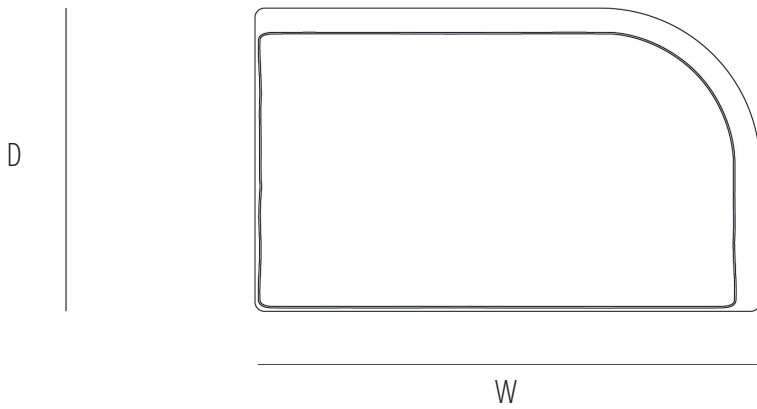

	H	W	D	SH	AH
mm	420	1600	950	420	
inch	16,5	62,9	37,4	16,5	

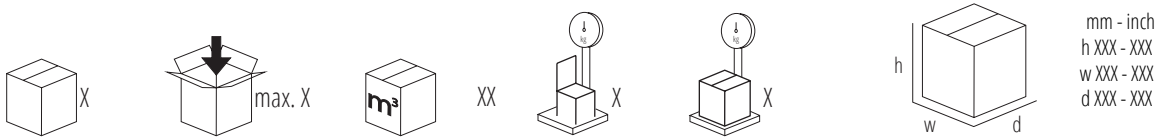

mm - inch  
 h XXX - XXX  
 w XXX - XXX  
 d XXX - XXX

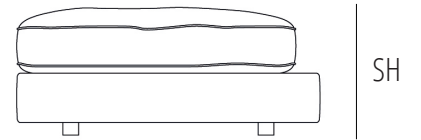
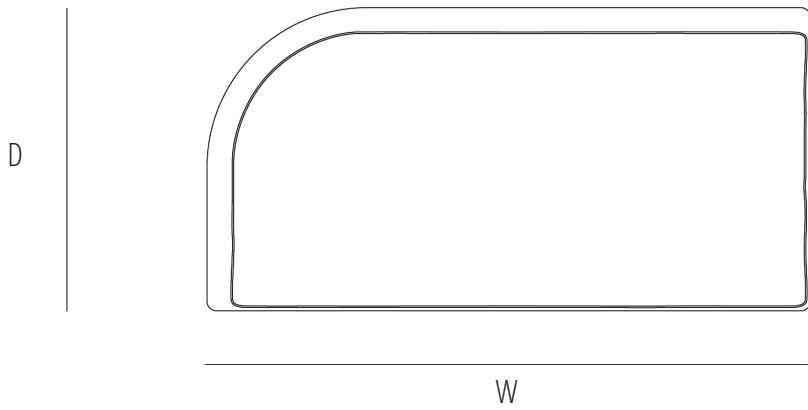

	H	W	D	SH	AH
mm	420	1900	950	420	
inch	16,5	74,8	37,4	16,5	

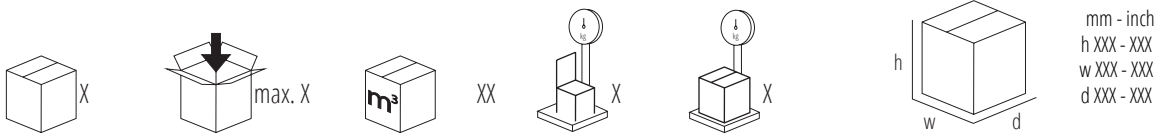

mm - inch  
 h XXX - XXX  
 w XXX - XXX  
 d XXX - XXX

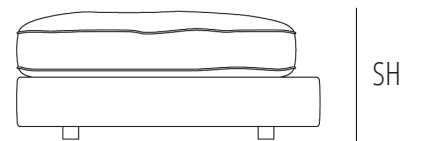
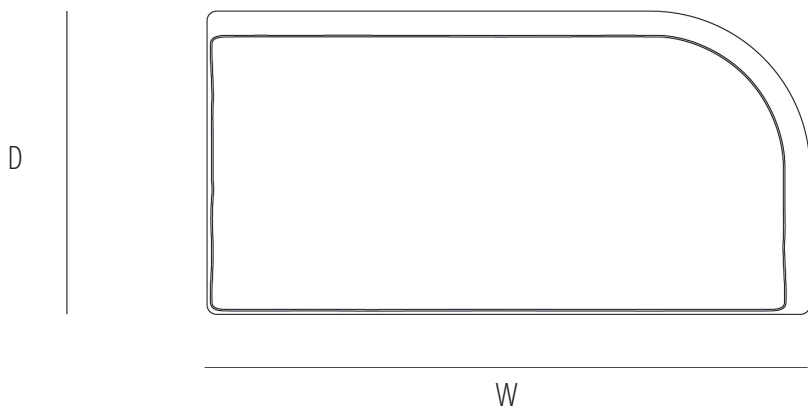

	H	W	D	SH	AH
mm	420	1900	950	420	
inch	16,5	74,8	37,4	16,5	

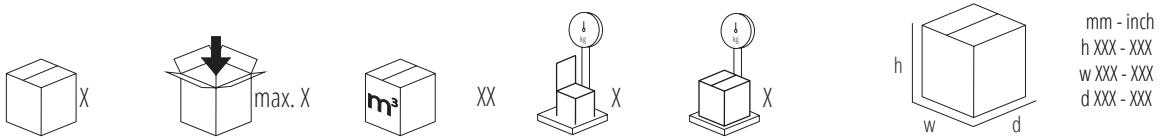

mm - inch  
 h XXX - XXX  
 w XXX - XXX  
 d XXX - XXX

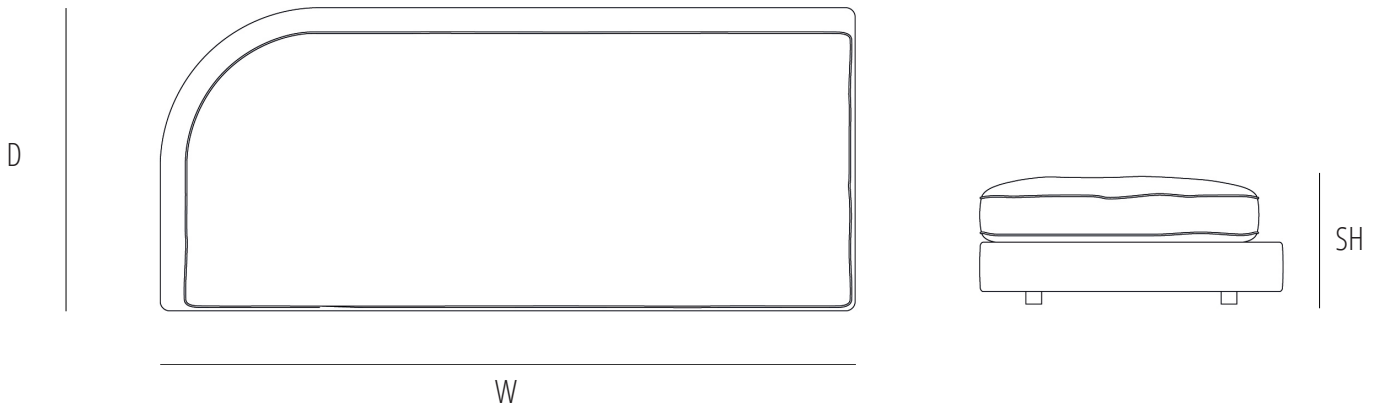

	H	W	D	SH	AH
mm	420	2200	950	420	
inch	16,5	86,6	37,4	16,5	

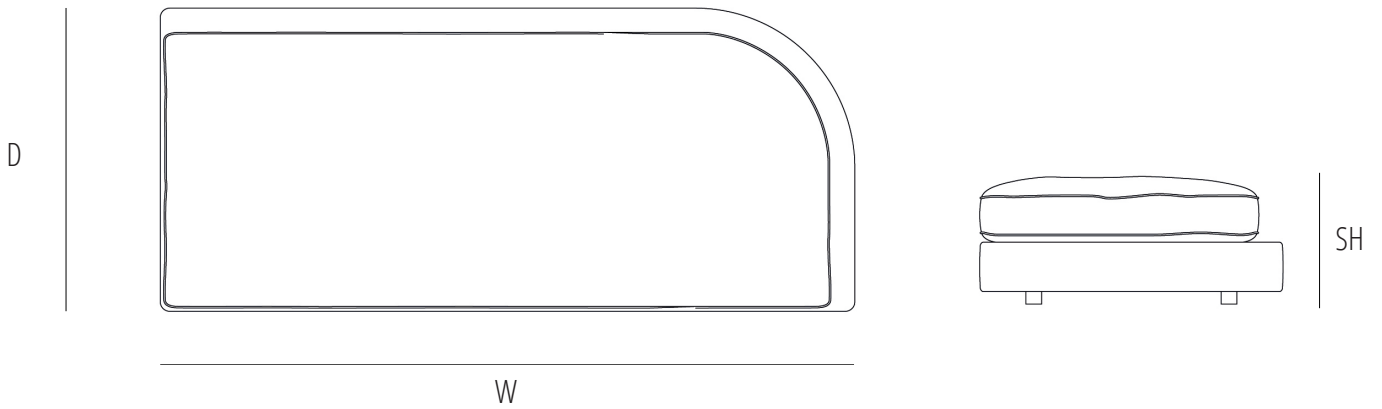
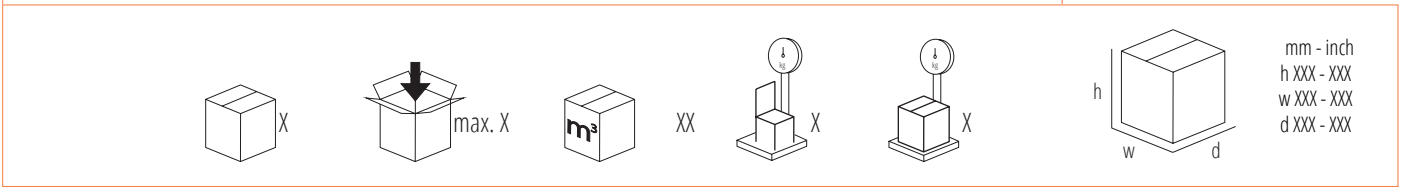

	H	W	D	SH	AH
mm	420	2200	950	420	
inch	16,5	86,6	37,4	16,5	

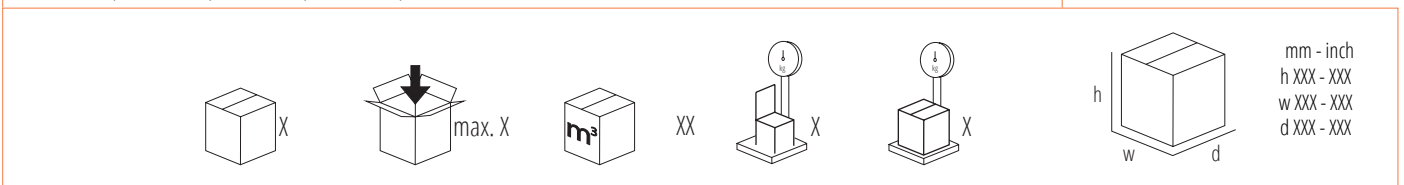

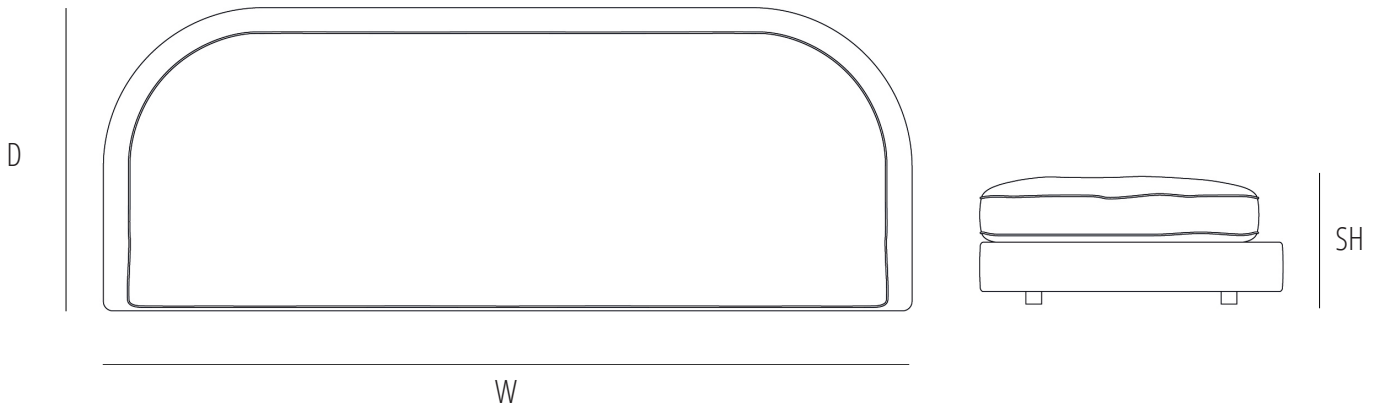

	H	W	D	SH	AH
mm	420	2550	950	420	
inch	16,5	100,3	37,4	16,5	

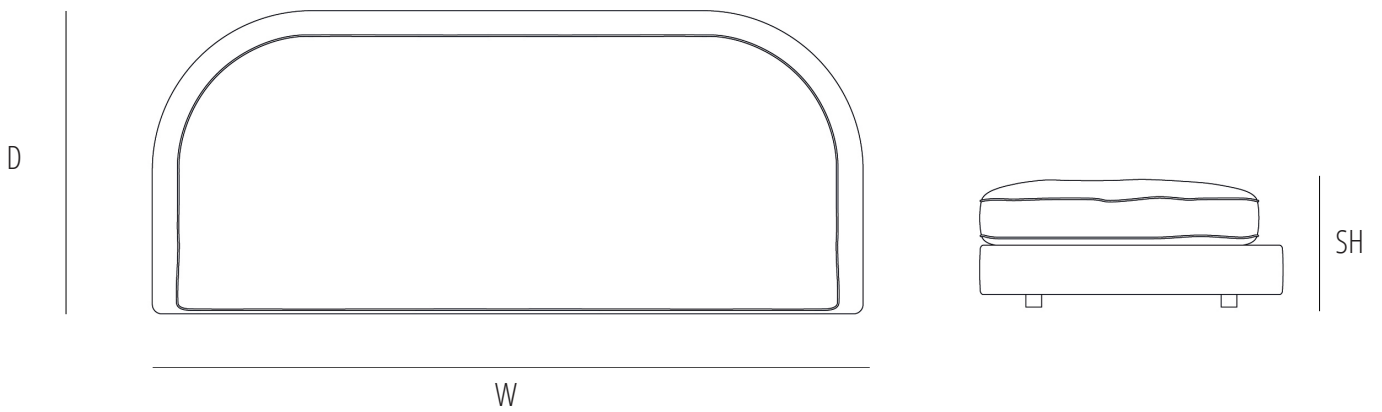
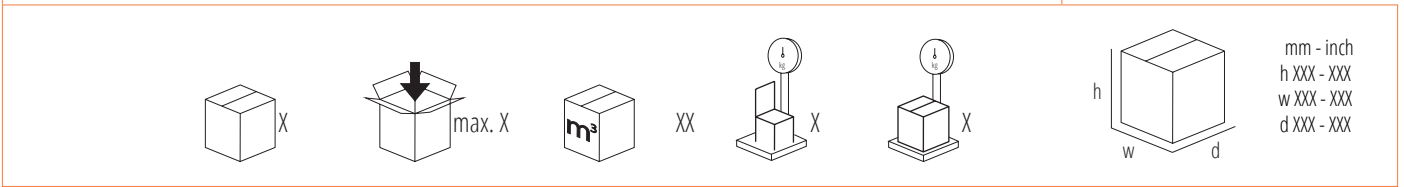

	H	W	D	SH	AH
mm	420	2250	950	420	
inch	16,5	88,5	37,4	16,5	

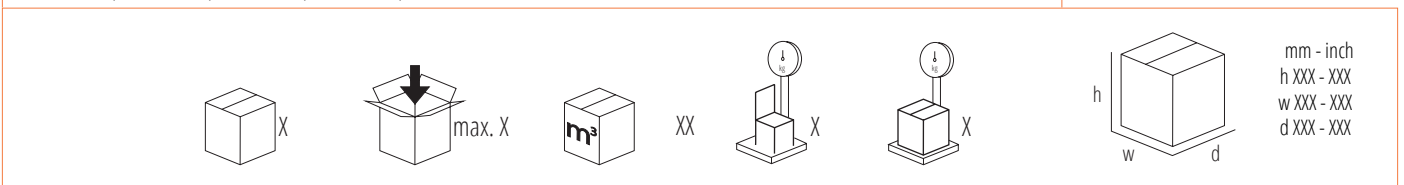



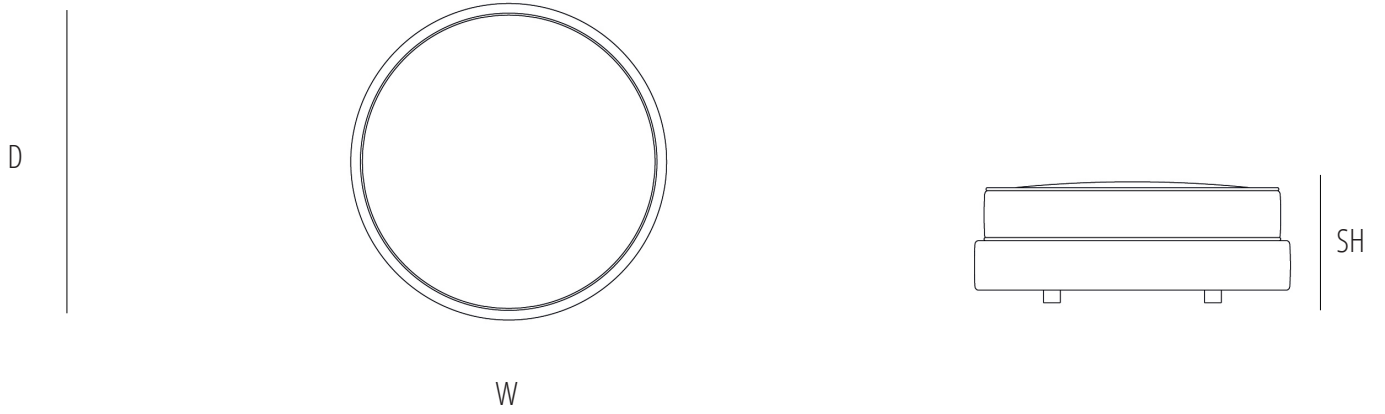



	H	W	D	SH	AH
mm	420	1000	1000	420	
inch	16,5	39,3	39,3	16,5	







XX

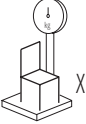



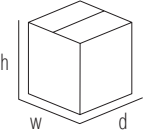

mm - inch  
 h XXX - XXX  
 w XXX - XXX  
 d XXX - XXX



D

	H	W	D	SH	AH
mm	460	1200	200		
inch	18,1	47,2	7,8		



XX

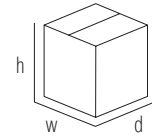
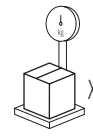
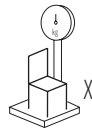

mm - inch  
h XXX - XXX  
w XXX - XXX  
d XXX - XXX

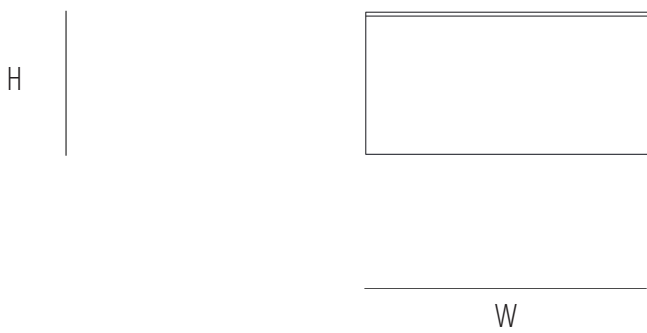

D

	H	W	D	SH	AH
mm	460	900	200		
inch	18,1	35,4	7,8		



XX

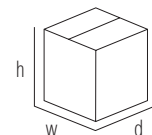
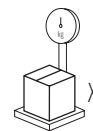
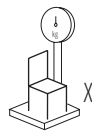

mm - inch  
h XXX - XXX  
w XXX - XXX  
d XXX - XXX

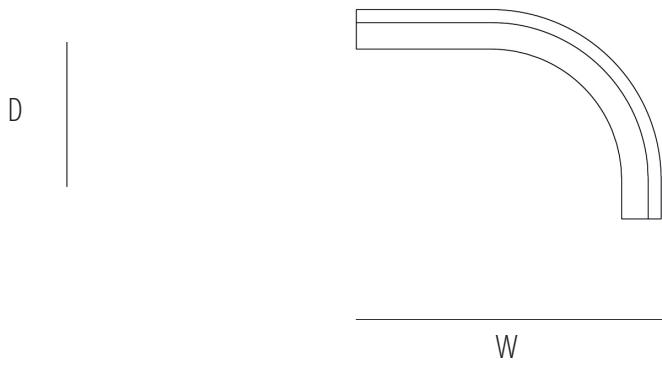

	H	W	D	SH	AH
mm	460	950	680		
inch	18,1	37,4	26,7		

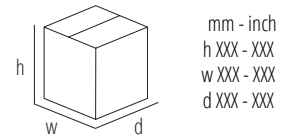
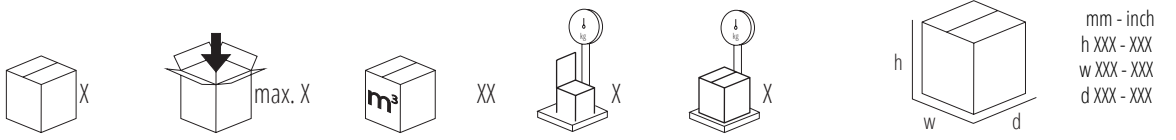

mm - inch  
 h XXX - XXX  
 w XXX - XXX  
 d XXX - XXX

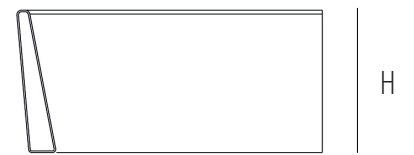
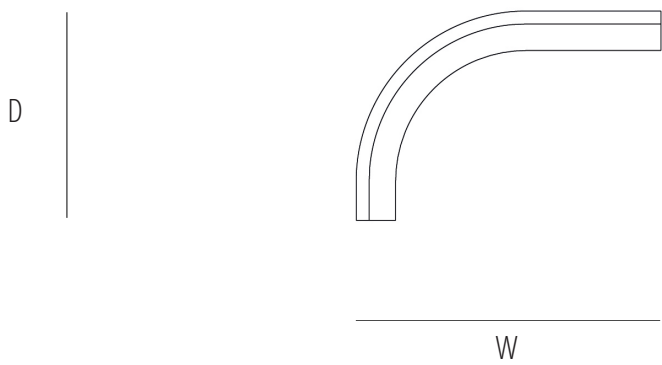

	H	W	D	SH	AH
mm	460	950	680		
inch	18,1	37,4	26,7		

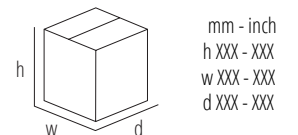
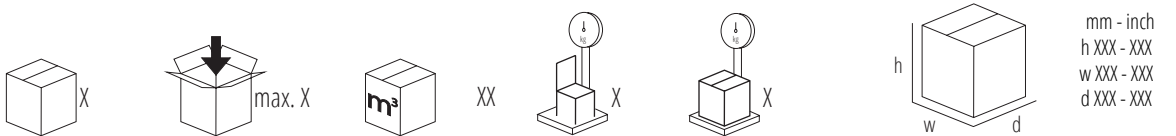

mm - inch  
 h XXX - XXX  
 w XXX - XXX  
 d XXX - XXX



	H	W	D	SH	AH
mm	460	680	680		
inch	18,1	26,7	26,7		



XX

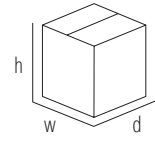
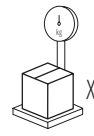

mm - inch  
 h XXX - XXX  
 w XXX - XXX  
 d XXX - XXX

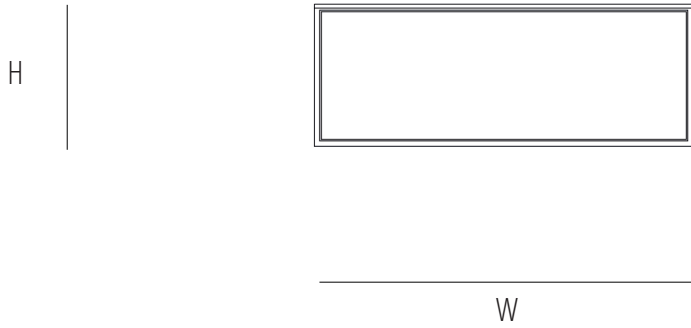

	H	W	D	SH	AH
mm	460	1200	200		
inch	18,1	47,2	7,8		

Logistics icons and unit conversion table:

- Cube X
- Open box max. X
- Cube  $m^3$
- XX
- Pallet X
- Pallet X
- Cube with dimensions h, w, d

mm - inch
h XXX - XXX
w XXX - XXX
d XXX - XXX

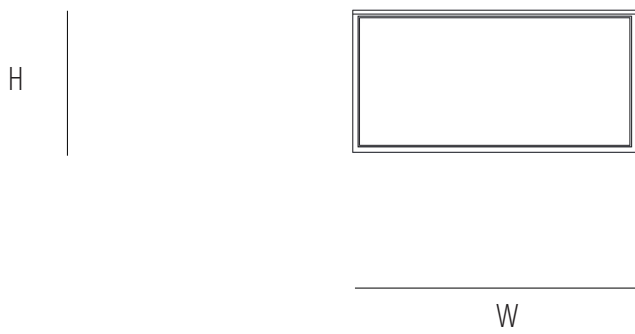

	H	W	D	SH	AH
mm	460	900	200		
inch	18,1	35,4	7,8		



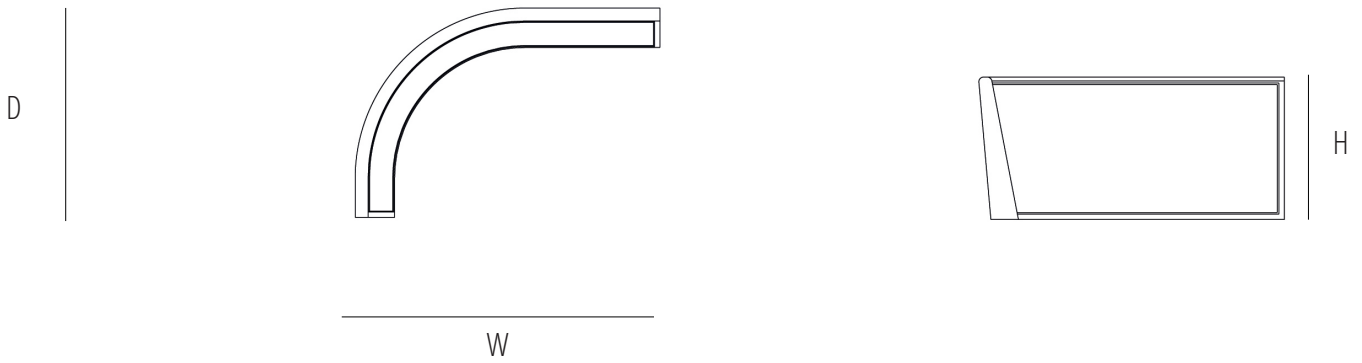

Logistics icons and unit conversion table:

- Cube X
- Open box max. X
- Cube  $m^3$
- XX
- Pallet X
- Pallet X
- Cube with dimensions h, w, d

mm - inch
h XXX - XXX
w XXX - XXX
d XXX - XXX





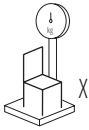
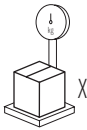
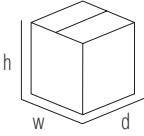

	H	W	D	SH	AH
mm	460	950	680		
inch	18,1	37,4	26,7		

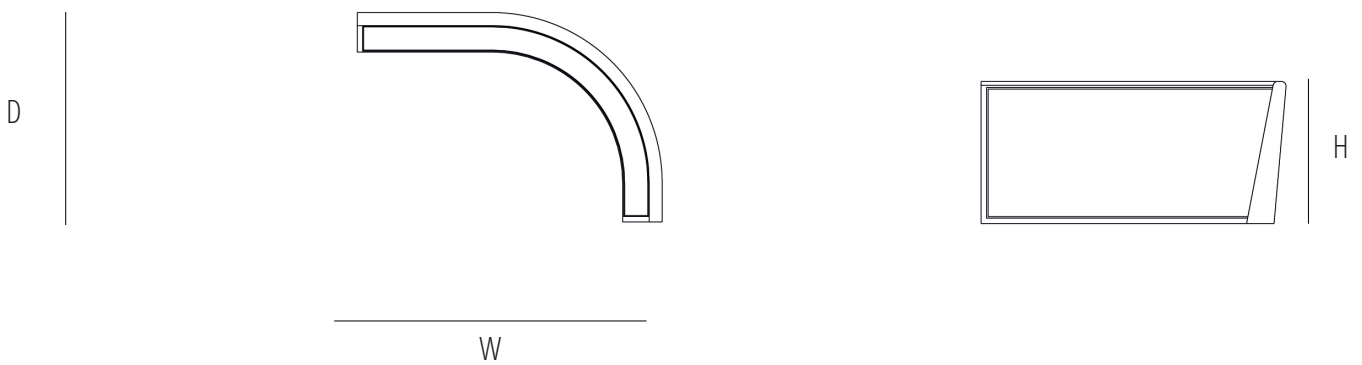
mm - inch  
h XXX - XXX  
w XXX - XXX  
d XXX - XXX



	H	W	D	SH	AH
mm	460	950	680		
inch	18,1	37,4	26,7		

mm - inch  
h XXX - XXX  
w XXX - XXX  
d XXX - XXX

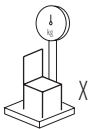
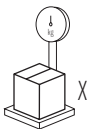
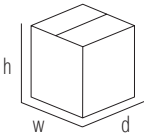

	H	W	D	SH	AH
mm	460	680	680		
inch	18,1	26,7	26,7		



X



max. X



$m^3$

XX

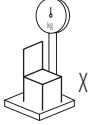

X

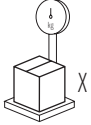

X

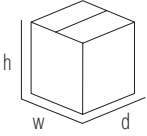

h  
w d

mm - inch  
h XXX - XXX  
w XXX - XXX  
d XXX - XXX

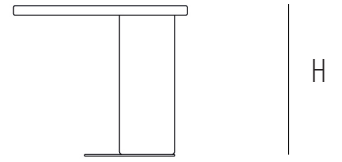
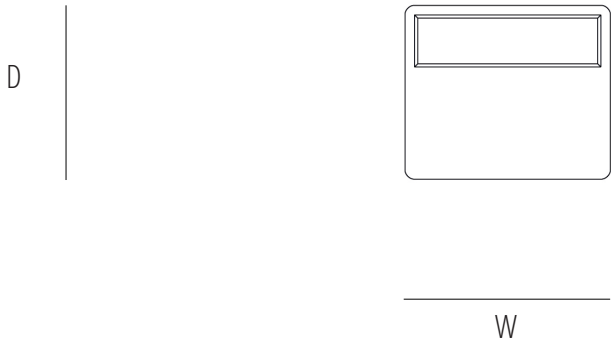

	H	W	D	SH	AH
mm	475	650	550		
inch	18,7	25,5	21,6		

mm - inch  
h XXX - XXX  
w XXX - XXX  
d XXX - XXX

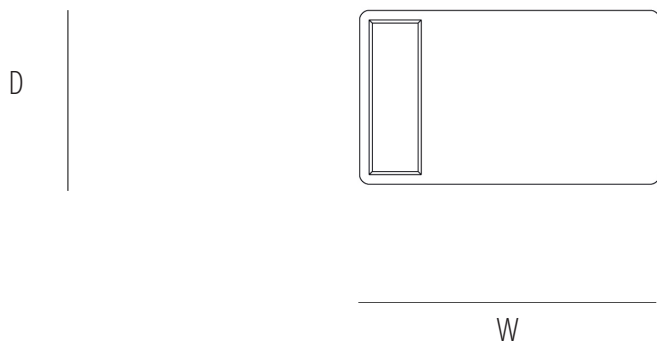

	H	W	D	SH	AH
mm	340	950	550		
inch	13,3	37,4	21,6		

mm - inch  
h XXX - XXX  
w XXX - XXX  
d XXX - XXX



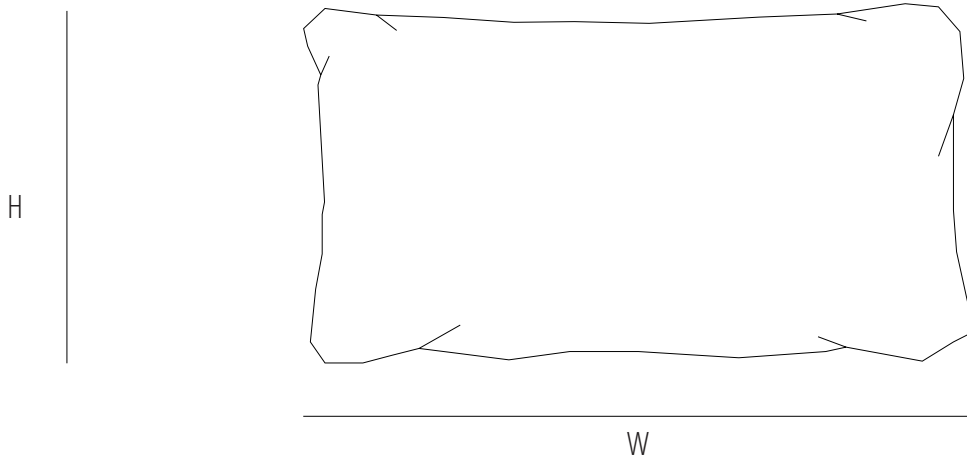

	H	W	D	SH	AH
mm	580	1050			
inch	22,8	41,3			

mm - inch  
 h XXX - XXX  
 w XXX - XXX  
 d XXX - XXX

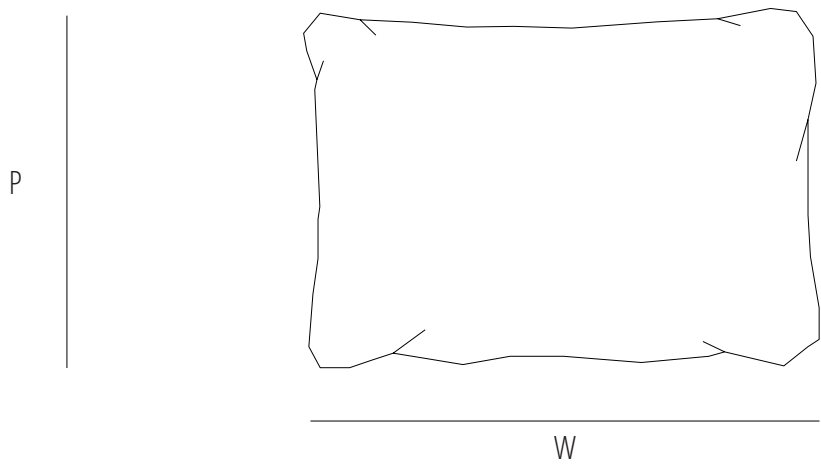

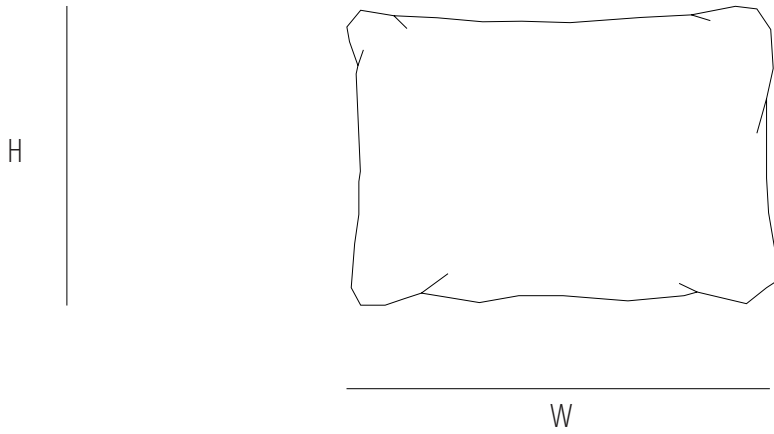

	H	W	D	SH	AH
mm	580	750			
inch	22,8	29,5			

mm - inch  
 h XXX - XXX  
 w XXX - XXX  
 d XXX - XXX

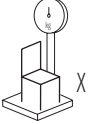
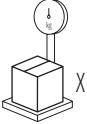
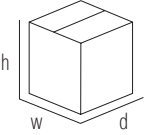

	H	W	D	SH	AH
mm	480	620			
inch	18,8	24,4			

			XX				mm - inch h XXX - XXX w XXX - XXX d XXX - XXX
---	---	---	----	--	---	--	--

Verfuegbare Ausfuehrungen  
Finiture disponibili  
Available finishes  
Finitions disponibles

**SOLID WOOD / ESSENZE NATURALI**

---



B07 ASH  
B07 FRASSINO

Gebrüder Thonet Vienna GmbH  
Prinz Eugen Straße 42  
1040 Wien (AT)

**[www.gebruederthonetvienna.com](http://www.gebruederthonetvienna.com)**

Offices of the trademarks' licensee  
Production Furniture International S.p.A.  
Via Foggia, 23/H  
10152 Torino (TO) Italy

Phone: 0039 011 0133330 - [info@gebruederthonetvienna.com](mailto:info@gebruederthonetvienna.com)