



# MOS COLLECTION

TECHNISCHES BLATT  
SCHEMA TECNICA  
DATA SHEET  
FICHE TECHNIQUE

# MOS

DESIGN GAMFRATESI, 2020



Bücherregal mit Buchenbugholzgestell und eingesetztem Wiener Geflecht. Regale aus offenporigem, lackiertem Eschefurnier. Messing-Füßen.

Libreria con struttura in faggio curvato e inserti in paglia di Vienna. Ripiani impiallacciati in frassino verniciato a poro aperto. Puntali in ottone.

Bookcase with bent beech-wood frame and woven cane inserts. Open pore painted shelves in ash veneer. Brass feet.

Bibliothèque avec structure en hêtre cintré et inserts en paille de Vienne. Étagères en plaqué frêne teinté à pores ouverts. Pieds en laiton.

Librería independiente con estructura de haya curvada e inserciones en paja de Viena. Estantes chapados en fresno barnizado a poro abierto. Puntas de latón.

Schrank mit Buchenbugholzgestell und eingesetztem Wiener Geflecht. Regale aus offenporigem, lackiertem Eschefurnier. Messing-Füßen.

Console con struttura in faggio curvato e inserti in paglia di Vienna. Ripiani impiallacciati in frassino verniciato a poro aperto. Puntali in ottone.

Console with bent beech-wood frame and woven cane inserts. Open pore painted shelves in ash veneer. Brass feet.

Console avec structure en hêtre cintré et inserts en paille de Vienne. Étagères en plaqué frêne teinté à pores ouverts. Pieds en laiton.

Consola con estructura en haya curvada y paneles laterales y traseros en paja de Viena. Estantes chapados en fresno barnizado a poro abierto. Puntas de latón.

Beistelltisch mit Buchenbugholzgestell und eingesetztem Wiener Geflecht. Regale aus offenporigem, lackiertem Eschefurnier. Messing-Füßen.

Tavolino con struttura in faggio curvato e inserti in paglia di Vienna. Ripiani in impiallacciato frassino verniciato a poro aperto. Puntali in ottone.

Side table with bent beech-wood frame and woven cane inserts. Open pore painted shelves in ash veneer. Brass feet.

Table basse avec structure en hêtre cintré et inserts en paille de Vienne. Étagères en plaqué frêne teinté à pores ouverts. Pieds en laiton.

Mesa de centro con estructura en haya curvada y paneles laterales y traseros en paja de Viena. Estantes chapados en fresno barnizado a poro abierto. Puntas de latón.



**LBMOSGPG**

Dimensions mm.  
height 1430 | width 1360 | depth 430



**CNMOSGPGC**

Dimensions mm.  
height 910 | width 1360 | depth 430



**CNMOSAPGC**

Dimensions mm.  
height 910 | width 1360 | depth 430



**TBMOSGLGP**

Dimensions mm.  
height 450 | width 500 | depth 470

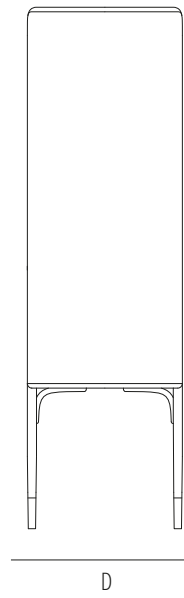
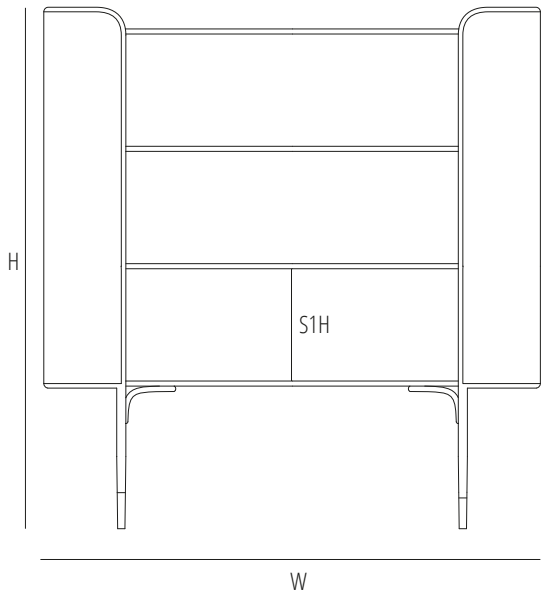

	H	W	D	SH	AH	S1H
mm	1430	1360	430			290
inch	56,2	53,5	16,9			11,4

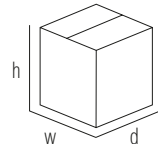
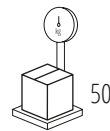
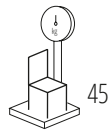

mm - inch  
h 1450 - 57,0  
w 1410 - 55,1  
d 500 - 19,6

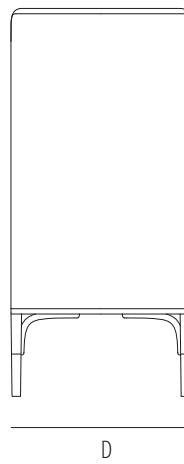
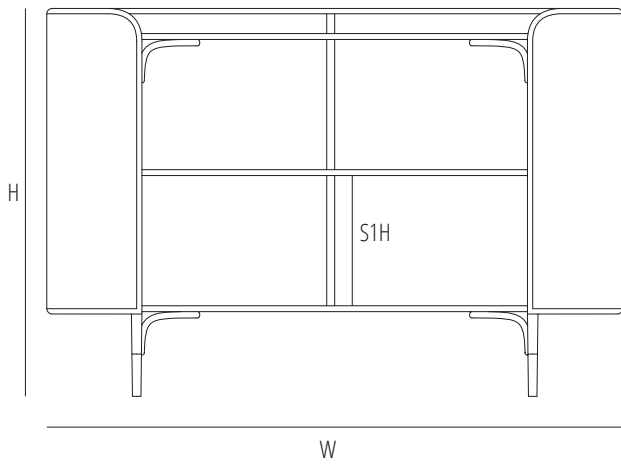

	H	W	D	SH	AH	S1H
mm	910	1360	430			290
inch	35,8	53,5	16,9			11,4

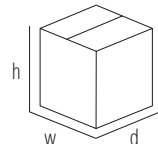
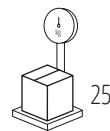
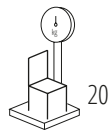

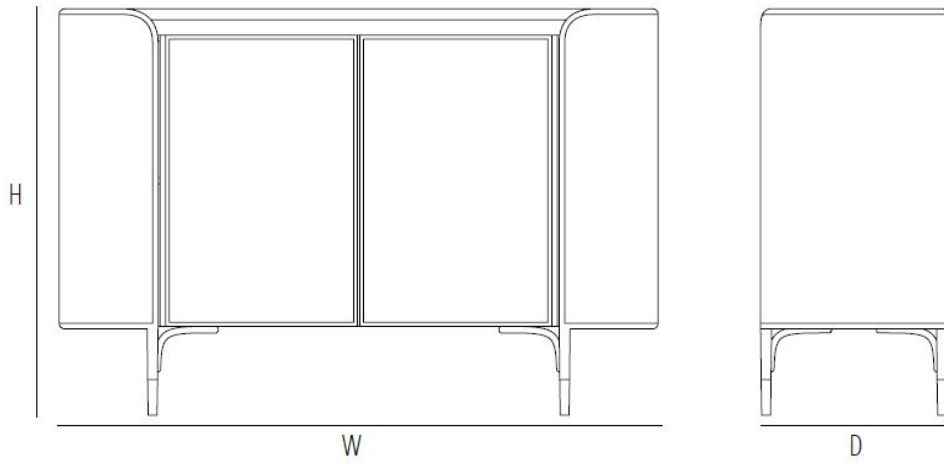

mm - inch  
h 1000 - 39,7  
w 1400 - 55,1  
d 500 - 19,6



	H	W	D	SH	AH	S1H
mm	910	1360	430			
inch	35,8	53,5	16,9			

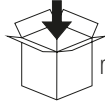

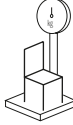
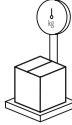
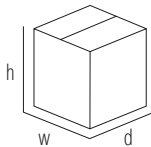

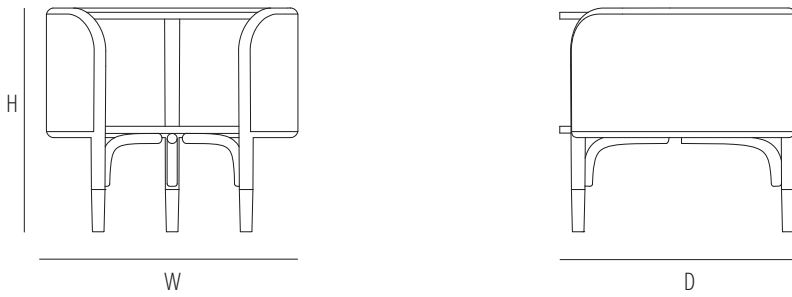
 1	 max. 1	 0,67	 25	 30		mm - inch h 950 - 37,4 w 1400 - 55,1 d 500 - 19,6
---	--	--	--	---	---	--

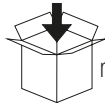

	H	W	D	SH	AH	S1H
mm	450	500	470			
inch	17,7	19,6	18,5			

 1	 max. 1	 0,143	 5	 8		mm - inch h 500 - 19,6 w 550 - 21,6 d 520 - 20,4
---	--	---	---	--	---	---

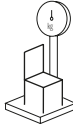
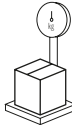
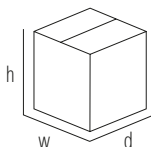
Verfuegbare Ausfuehrungen  
Finiture disponibili  
Available finishes  
Finitions disponibles

## SOLID WOOD / ESSENZE NATURALI

### FRAME



B01 BEECH  
B01 FAGGIO

### SHELVES



B07 ASH  
B07 FRASSINO

## CLASSIC LACQUER / LACCATO CLASSICO

\*Ash wood is open-pore painted  
\* L'essenza frassino è verniciata a poro aperto

### FRAME / SHELVES



C01 - RAL 9005 BLACK

## STABILITY TESTS FOR MOS BOOKCASE

1. Stability EN 14749:2016, Sec. 5.4.
2. Stability EN 16122:2012 + AC:2015, par. 11

Gebrüder Thonet Vienna GmbH  
Prinz Eugen Straße 42  
1040 Wien (AT)

**[www.gebruederthonetvienna.com](http://www.gebruederthonetvienna.com)**

Offices of the trademarks' licensee  
Production Furniture International S.p.A.  
Via Foggia, 23/H  
10152 Torino (TO) Italy

Phone: 0039 011 0133330 - [info@gebruederthonetvienna.com](mailto:info@gebruederthonetvienna.com)